

14

# Bone Surgery

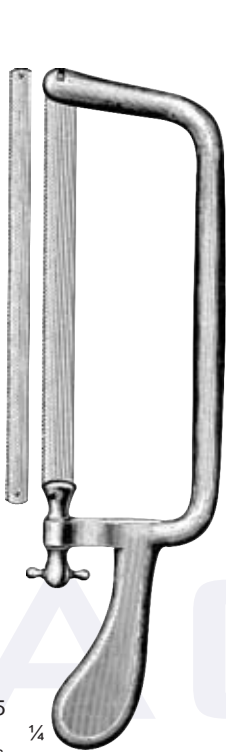

Amputating and Resection Saws

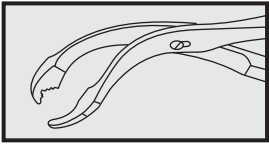

**Charriere**  
DC14-001-35  
35 cm / 14"  
with 2 saw blades,  
12 and 15 mm wide

¼

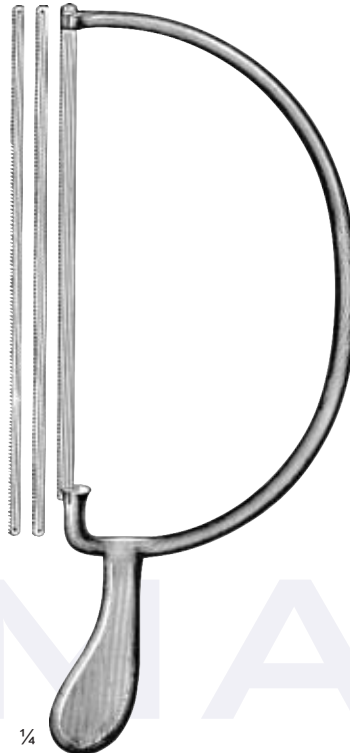

**Helferich-Bier**  
DC14-003-39  
39 cm / 15½"  
adjustable, with  
3 saw blades, 3, 5  
and 7 mm wide

¼

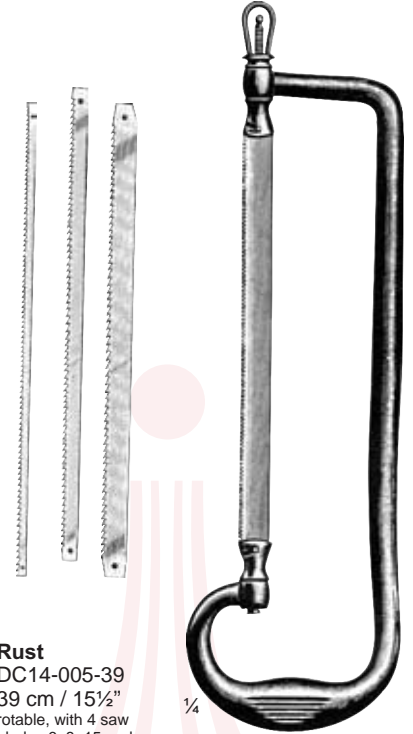

**Rust**  
DC14-005-39  
39 cm / 15½"  
rotatable, with 4 saw  
blades, 6, 8, 15 and  
18 mm wide

¼



**Linemann**  
DC14-007-20  
20 cm / 8" ⅓



**Langenbeck**  
DC14-009-23  
23 cm / 9" ⅓

⅓



**Charriere**  
DC14-011-27 = 27cm/10 ½"  
DC14-011-30 = 30cm/12"  
Blade Saws, interchangeable blades



**Satterlee**  
DC14-013-31  
31 cm / 12¼"  
Blade Saws,  
interchangeable blades

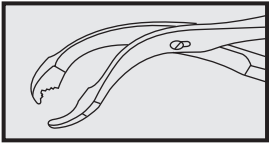

Bone Drills, Reamers, Hand Bone Drills

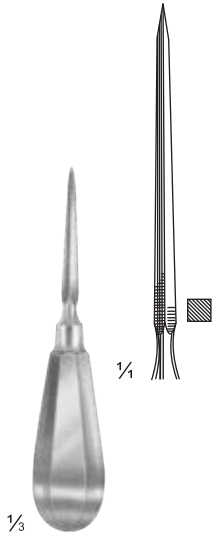

DC14-015-14  
14cm / 5½"



**Perthes**  
DC14-017-21  
21 cm / 8¼"

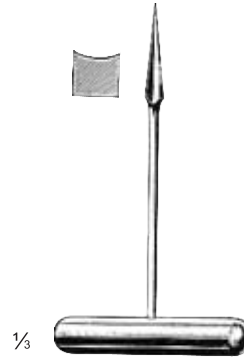

DC14-019-14  
14 cm / 5½"



**Adson**  
DC14-021-15  
15 cm / 6"  
Drill Guide Dura  
Protecting Forceps

ACMA  
INTERNATIONAL

Twist Drills

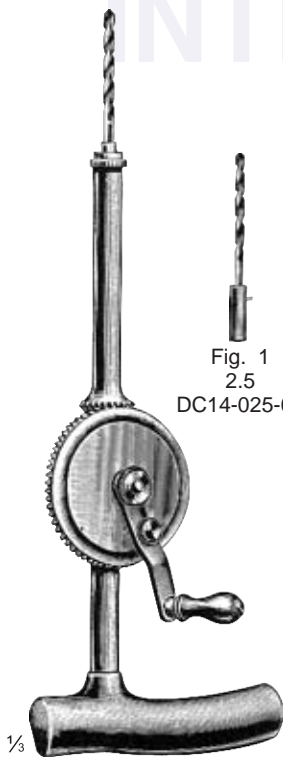

**Stille-Sherman**  
DC14-023-00  
24 cm / 9½"

Hand Drill with 3 twist drills fig. 1-3

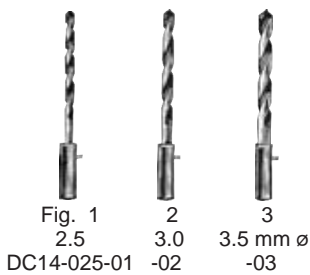
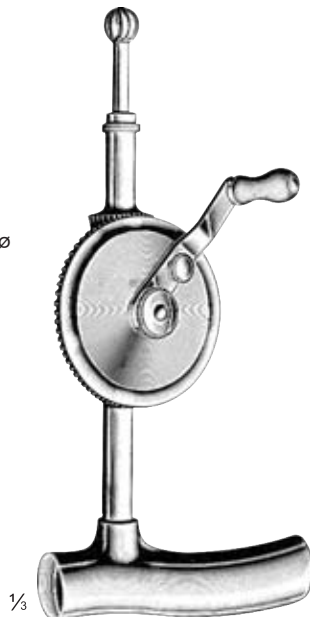

Fig. 1  
2.5  
DC14-025-01

2  
3.0  
-02

3  
3.5 mm ø  
-03



**Stille**  
DC14-027-00  
20 cm / 8"

Twist Drills and Spherical Burrs only

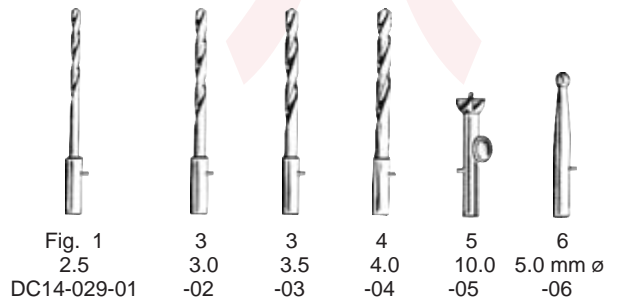

Fig. 1  
2.5  
DC14-029-01

3  
3.0  
-02

3  
3.5  
-03

4  
4.0  
-04

5  
10.0  
-05

6  
5.0 mm ø  
-06

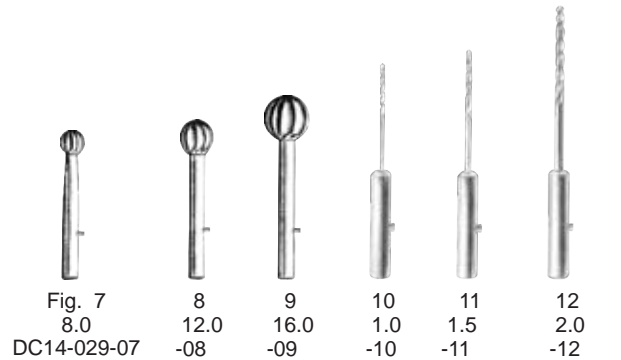

Fig. 7  
8.0  
DC14-029-07

8  
12.0  
-08

9  
16.0  
-09

10  
1.0  
-10

11  
1.5  
-11

12  
2.0  
-12

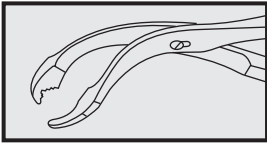

Hammer

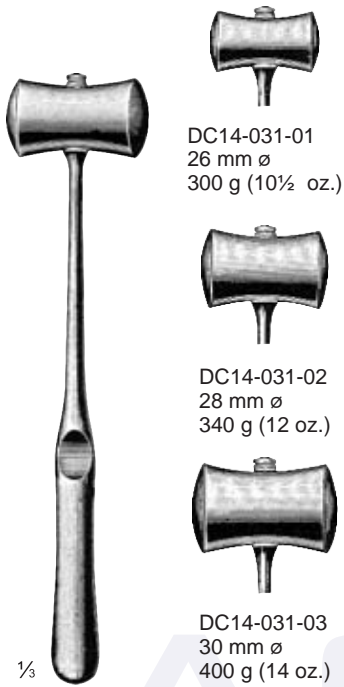

DC14-031-01  
26 mm ø  
300 g (10½ oz.)



DC14-031-02  
28 mm ø  
340 g (12 oz.)



DC14-031-03  
30 mm ø  
400 g (14 oz.)

**Williger**  
24 cm / 9½"  
lead filled

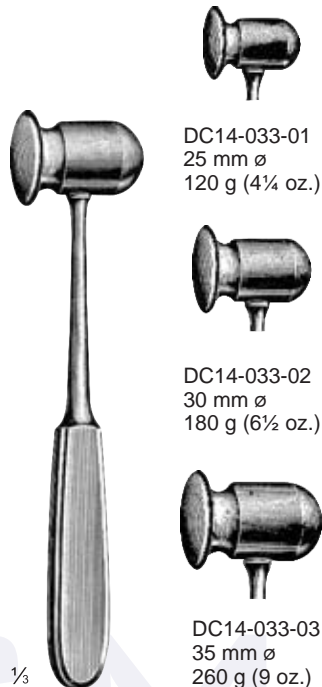

DC14-033-01  
25 mm ø  
120 g (4¼ oz.)



DC14-033-02  
30 mm ø  
180 g (6½ oz.)



DC14-033-03  
35 mm ø  
260 g (9 oz.)

**Doyen**  
21 cm / 8¼"  
brass, solid



30 mm ø  
220 g  
(7¾ oz.)



**Collin**  
DC14-035-20  
20 cm / 8"  
brass, solid

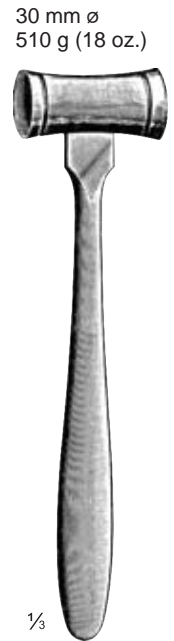

30 mm ø  
510 g (18 oz.)

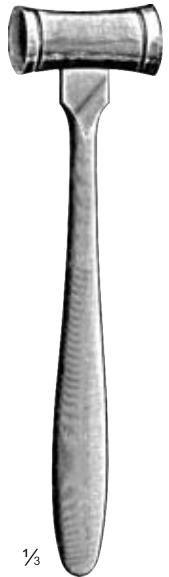

DC14-037-22  
22.5 cm / 9"  
steel, solid



26 mm ø  
320 g (11¼ oz.)

1/3

**Mead**  
DC14-039-17  
17 cm / 6¾"  
solid  
DC14-041-00  
Ferrozell Cheeks  
only, pair

with interchangeable  
Ferrozell Cheeks



20 mm ø  
140 g  
(5 oz.)

1/3

DC14-043-01  
lead filled  
DC14-043-02  
brass, solid  
16.5 cm / 6½"

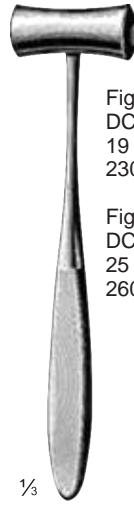

Fig. 1  
DC14-045-01  
19 mm ø  
230 g (8 oz.)

Fig. 2  
DC14-045-02  
25 mm ø  
260 g (9 oz.)

1/3

**Lucae**  
19 cm / 7½"  
brass, solid



1/3

DC14-047-24  
24 cm / 9½"

steel, solid,  
with plastic handle

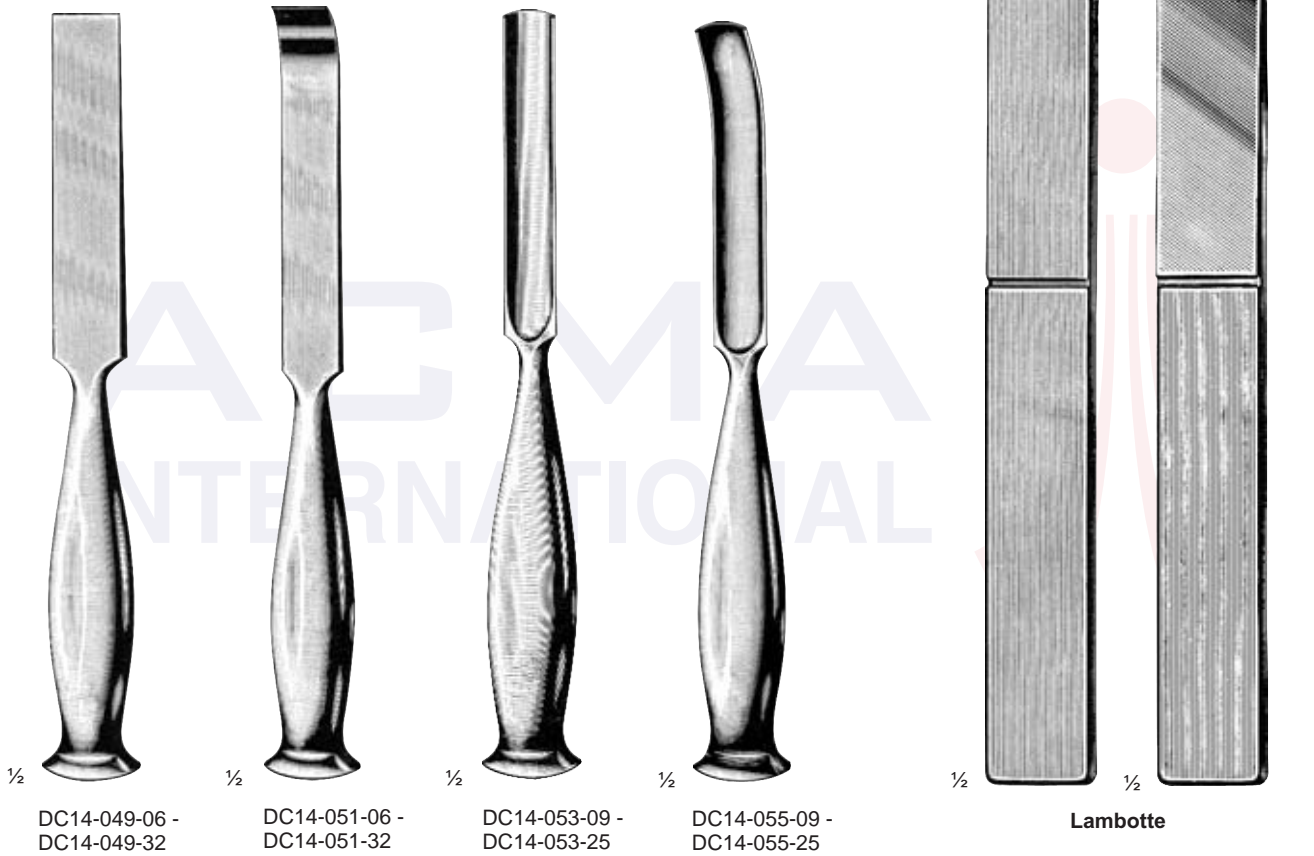
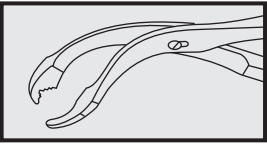

DC14-049-06 - DC14-049-32      DC14-051-06 - DC14-051-32      DC14-053-09 - DC14-053-25      DC14-055-09 - DC14-055-25

Lambotte

width		Smith-Petersen			
mm	20cm/8"	20cm/8"	20cm/8"	20cm/8"	
6	DC14-049-06	DC14-051-06			
9	DC14-049-09	DC14-051-09	DC14-053-09	DC14-055-09	
13	DC14-049-13	DC14-051-13			
14			DC14-053-14	DC14-055-14	
16	DC14-049-16	DC14-051-16			
19	DC14-049-19	DC14-051-19	DC14-053-19	DC14-055-19	
25	DC14-049-25	DC14-051-25	DC14-053-25	DC14-055-25	
32	DC14-049-32	DC14-051-32			

width		
mm	24 cm/9½"	23 cm/9"
15	DC14-057-15	DC14-059-15
20	DC14-057-20	DC14-059-20
25	DC14-057-25	DC14-059-25
30	DC14-057-30	DC14-059-30
38	DC14-057-38	DC14-059-38
44	DC14-057-44	DC14-059-44
50	DC14-057-50	DC14-059-50

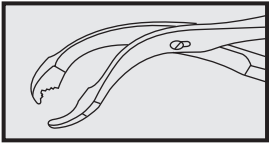

Bone Chisels and Gouges

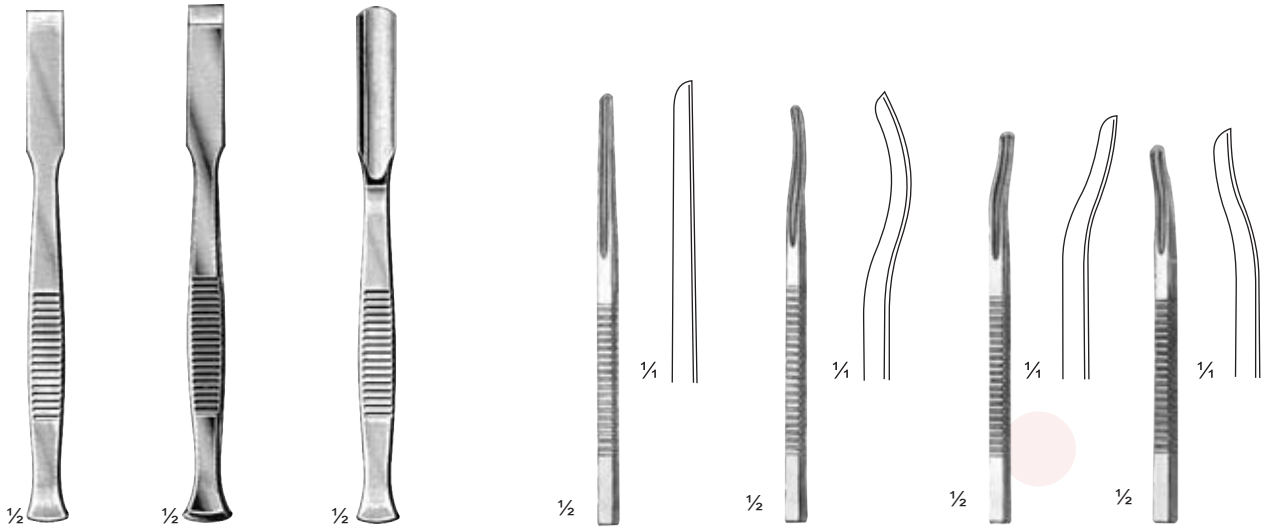

width mm	13.5 cm/5¼"	13.5 cm/5¼"	13.5 cm/5¼"
8	DC14-061-08	DC14-063-08	DC14-065-08
10	DC14-061-10	DC14-063-10	DC14-065-10
12	DC14-061-12	DC14-063-12	DC14-065-12
14	DC14-061-14	DC14-063-14	DC14-065-14
16	DC14-061-16	DC14-063-16	DC14-065-16

Buck-Gramcko  
DC14-067-01 DC14-067-02 DC14-067-03 DC14-067-04

MA  
INTERNATIONAL

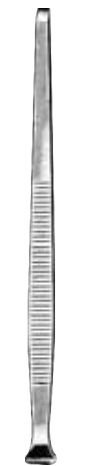

Partsch



Partsch



Alexander



Alexander

		width mm		
11.5 cm/4½"	13.5 cm/5¼"		11.5 cm/4½"	13.5 cm/5¼"
DC14-069-02	DC14-071-02	2	DC14-073-02	DC14-075-02
DC14-069-03	DC14-071-03	3	DC14-073-03	DC14-075-03
DC14-069-04	DC14-071-04	4	DC14-073-04	DC14-075-04
DC14-069-05	DC14-071-05	5	DC14-073-05	DC14-075-05
DC14-069-06	DC14-071-06	6	DC14-073-06	DC14-075-06
DC14-069-07	DC14-071-07	7	DC14-073-07	DC14-075-07
DC14-069-08	DC14-071-08	8	DC14-073-08	DC14-075-08

	width mm	
18 cm/7"		18 cm/7"
DC14-077-04	4	DC14-079-04
DC14-077-06	6	DC14-079-06
DC14-077-08	8	DC14-079-08
DC14-077-10	10	DC14-079-10
DC14-077-12	12	DC14-079-12
DC14-077-14	14	DC14-079-14

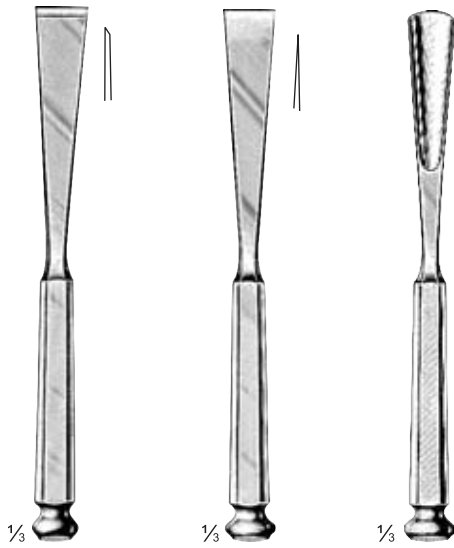
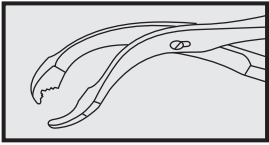

**Stille**

width mm	20 cm/8"	20 cm/8"	20 cm/8"
10	DC14-081-10	DC14-083-10	DC14-085-10
15	DC14-081-15	DC14-083-15	DC14-085-15
20	DC14-081-20	DC14-083-20	DC14-085-20
25	DC14-081-25	DC14-083-25	DC14-085-25



**Hoke**

width mm	17 cm/ 6 3/4"
3	DC14-087-03
5	DC14-087-05
6	DC14-087-06
8	DC14-087-08
9	DC14-087-09

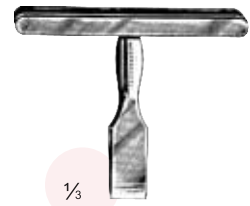

**Virchow**  
DC14-089-00

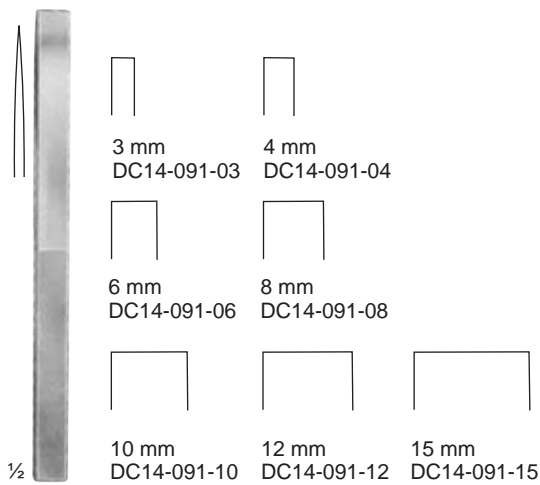

**Mini-Lambotte**  
12.5 cm / 5"

3 mm  
DC14-091-03

4 mm  
DC14-091-04

6 mm  
DC14-091-06

8 mm  
DC14-091-08

10 mm  
DC14-091-10

12 mm  
DC14-091-12

15 mm  
DC14-091-15



**Brunetti**  
DC14-093-28  
28 cm / 11"



**Brunetti**  
DC14-095-28  
28 cm / 11"



DC14-097-15 = 15 mm  
DC14-097-18 = 18 mm  
DC14-097-22 = 22 mm  
13.5 cm / 5 1/2"

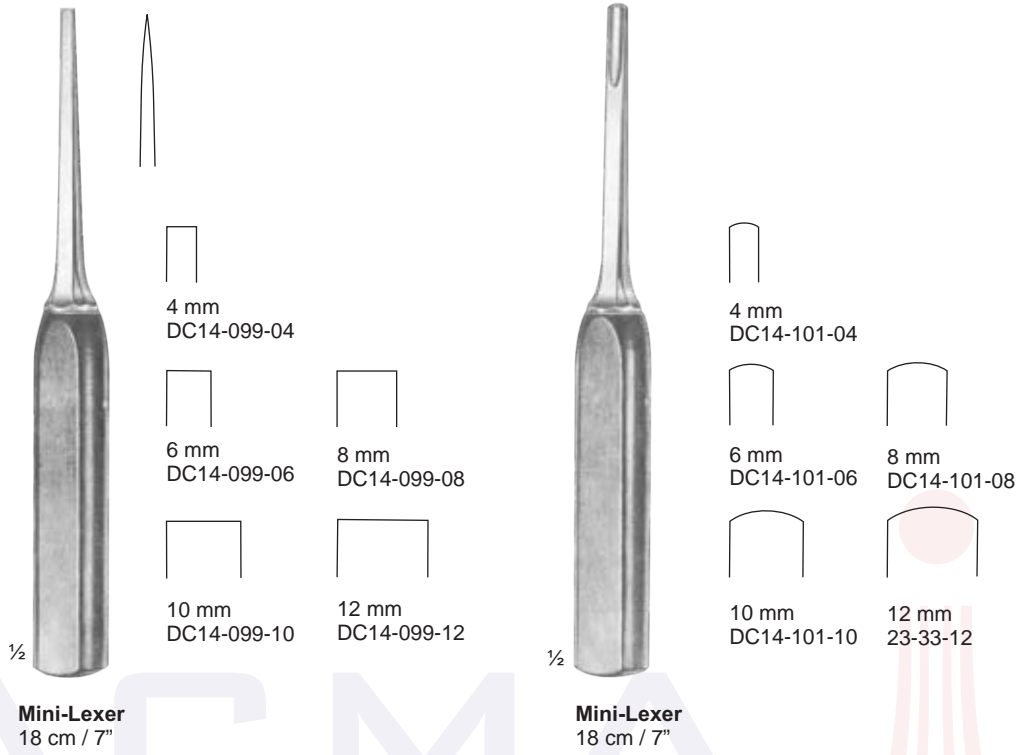
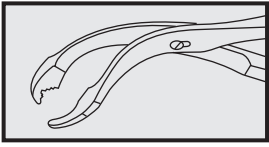

ACMA  
INTERNATIONAL

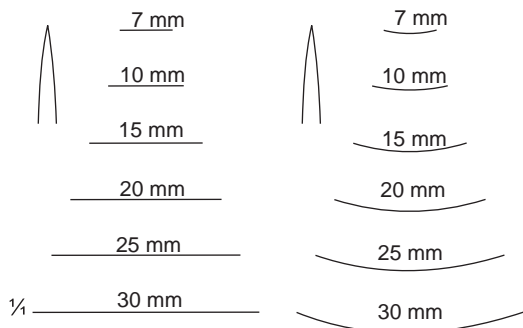

width mm	22 cm/8 1/2"	22 cm/8 1/2"
07	DC14-103-07	DC14-105-07
10	DC14-103-10	DC14-105-10
15	DC14-103-15	DC14-105-15
20	DC14-103-20	DC14-105-20
25	DC14-103-25	DC14-105-25
30	DC14-103-30	DC14-105-30

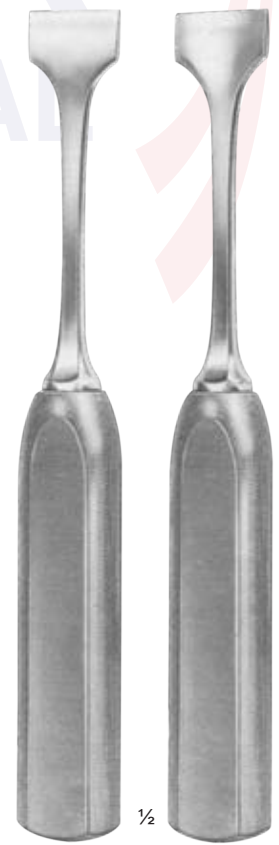

**Lexer**  
DC14-103-07- DC14-105-07-  
DC14-103-30 DC14-105-30



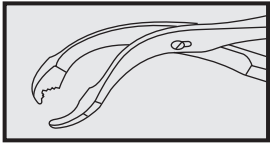

Periosteotomes, Chisels and Gouges  
Chisels for Oral and Maxillo-Facial Surgery

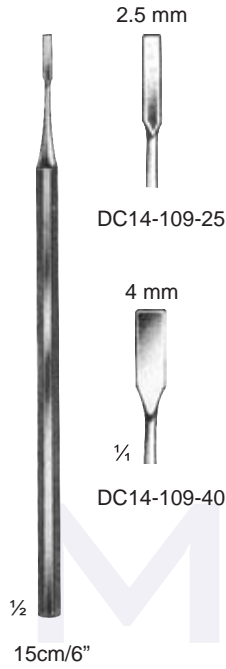

for sectionning of Alveolar Process between two roots

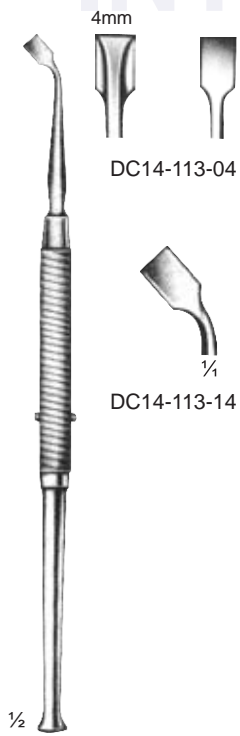
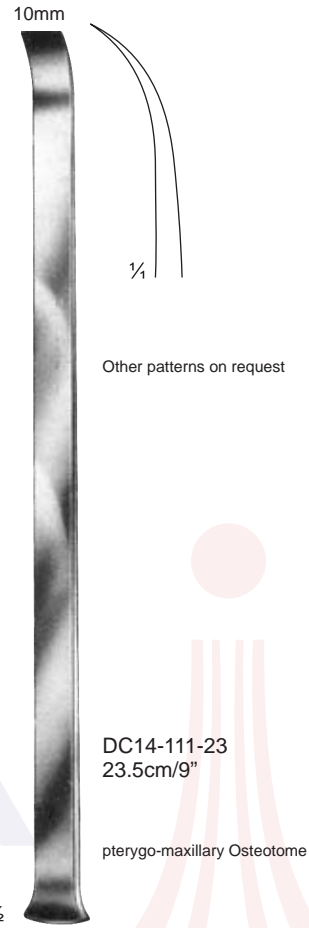

Freer  
19cm/7 1/2"



Freer  
DC14-115-14  
16cm/6 1/4"



Freer  
DC14-115-16  
16cm/6 1/4"

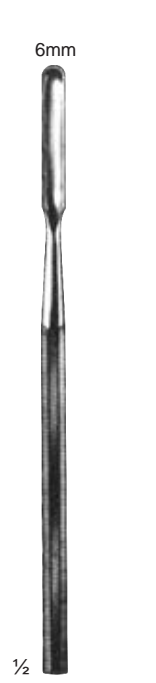

Freer  
DC14-117-15  
15cm/6"



West  
DC14-119-16  
16cm/6 1/4"

West  
DC14-121-16  
16cm/6 1/4"

Chisels and Gouges for Rhinology and Plastic Operations

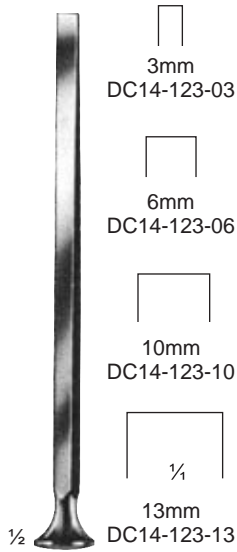
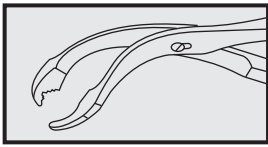

**Carroll (French Pattern)**  
14.5cm/5 3/4"

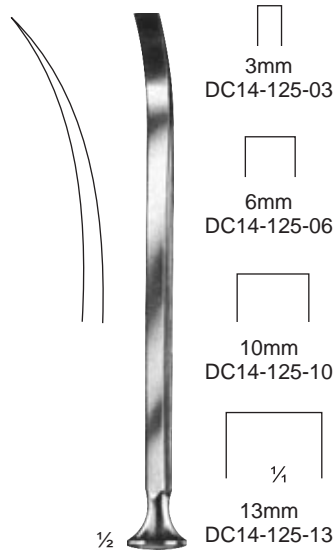

**Carroll (French Pattern)**  
14.5cm/5 3/4"

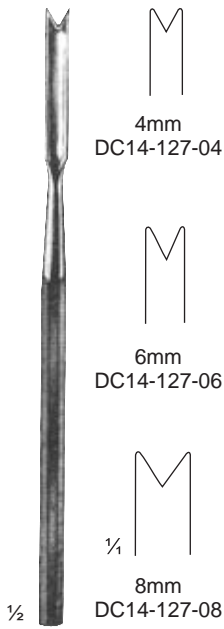

**Ballenger**  
15cm/6"



**Killian**  
DC14-129-05  
16cm/6 1/4"



**Killian**  
DC14-131-05  
16cm/6 1/4"

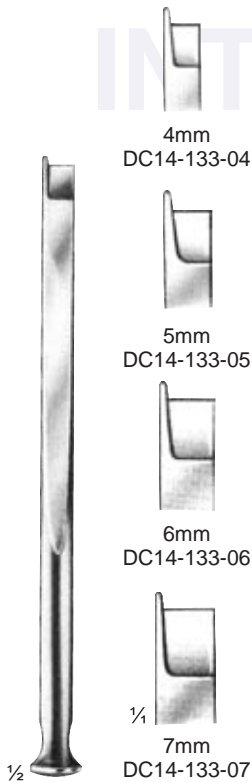

**Fomon**  
14.5cm/5 3/4"

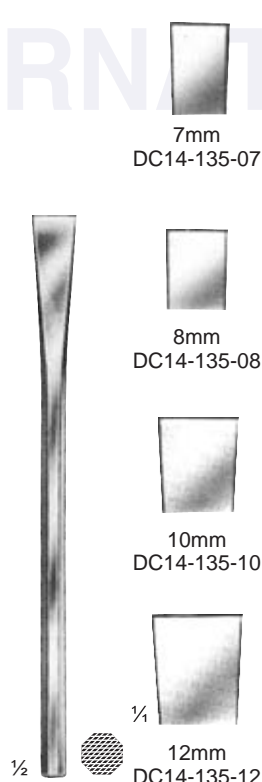

**Sheehan**  
15cm/6"

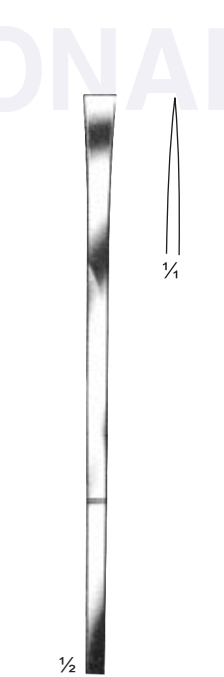

**Cottle**  
15cm/6"  
7mm DC14-137-07  
12mm DC14-137-12

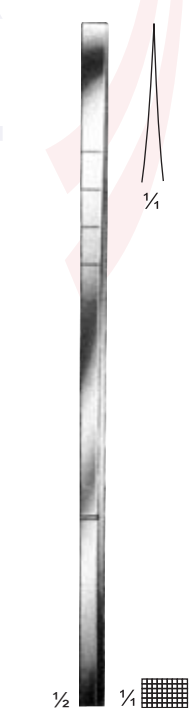

**Cottle**  
18cm/7"  
4mm DC14-139-04  
6mm DC14-139-06  
7mm DC14-139-07  
9mm DC14-139-09  
12mm DC14-139-12

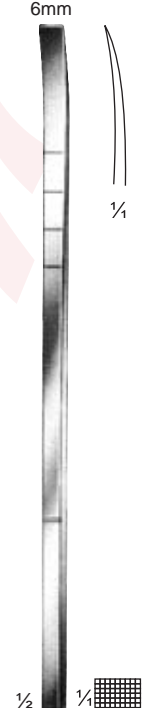

**Cottle**  
DC14-141-06  
18cm/7"

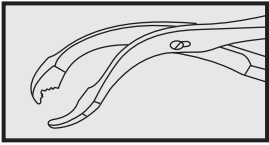

Bone Chisels and Gouges, Hemostats



**Putti**  
DC14-143-30  
30 cm / 12"

1/3



**Putti**  
DC14-145-27  
27 cm / 10 1/2"

1/3



1/2

15.5 cm / 6"

1/4 ●  
2 mm ø  
DC14-147-02

1/4 ●  
3 mm ø  
DC14-147-03

1/4 ●  
4 mm ø  
DC14-147-04

1/4 ●  
5 mm ø  
DC14-147-05

1/4 ●  
6 mm ø  
DC14-147-06

1/4 ●  
8 mm ø  
DC14-147-08

1/4 ●  
10 mm ø  
DC14-147-10



1/3



1/3



1/3



1/3



1/3

width

**Hibbs**

mm	24 mc/9 1/2"	24 mc/9 1/2"	24 mc/9 1/2"	24 mc/9 1/2"	24 mc/9 1/2"
6	DC14-149-06	DC14-151-06	DC14-153-06	DC14-155-06	DC14-157-06
13	DC14-149-13	DC14-151-13	DC14-153-13	DC14-155-13	DC14-157-13
19	DC14-149-19	DC14-151-19	DC14-153-19	DC14-155-19	DC14-157-19
25	DC14-149-25	DC14-151-25	DC14-153-25	DC14-155-25	DC14-157-25
32	DC14-149-32	DC14-151-32	DC14-153-32	DC14-155-32	DC14-157-32

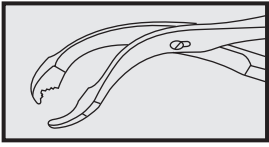

Gouges with Novotex (Ferozell) Handle

8mm



1/2

**Cobb**  
DC14-159-08  
28cm/11"

8mm



1/2

**Cobb**  
DC14-160-28  
28cm/11"

8mm



1/2

**Cobb**  
DC14-161-48  
28cm/11"

8mm



1/2

**Cobb**  
DC14-162-68  
28cm/11"

5mm

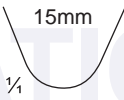
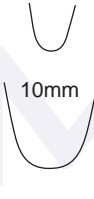

1/4



1/2

25cm/10"

5mm	DC14-163-05
10mm	DC14-163-10
15mm	DC14-163-15

5mm

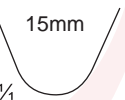

1/4



1/2

25cm/10"

5mm	DC14-164-05
10mm	DC14-164-10
15mm	DC14-164-15



1/2

**Zielke**  
23cm/9"

5.5mm	DC14-165-55
9.0mm	DC14-165-90

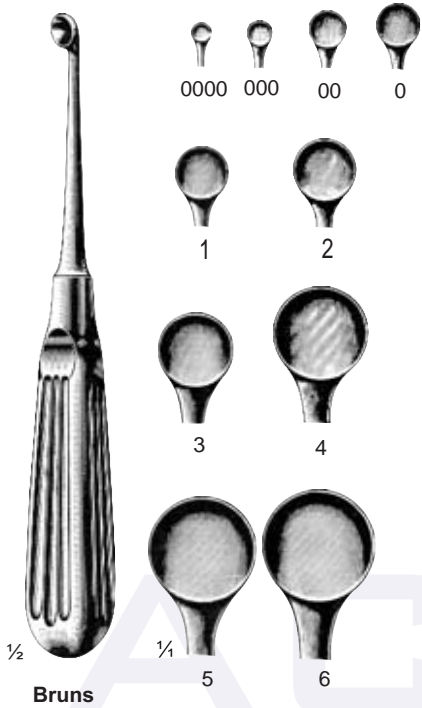
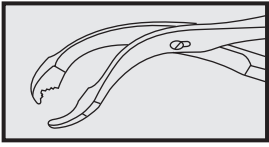

**Brun's**

DC14-167-30  
DC14-167-20  
DC14-167-10

DC14-169-01  
DC14-169-02  
DC14-169-03

DC14-169-04  
DC14-169-05  
DC14-169-06

**Fig.**

000  
00  
0

1  
2  
3  
4  
5  
6

**Spratt**

DC14-171-30  
DC14-171-20  
DC14-171-10

DC14-173-01  
DC14-173-02  
DC14-173-03

DC14-173-04  
DC14-173-05

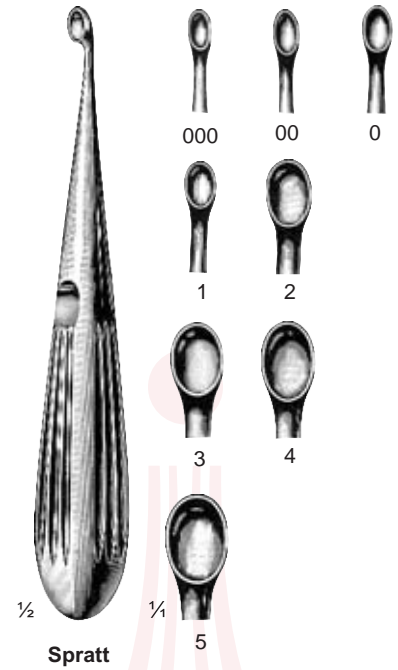

AGMA INTERNATIONAL

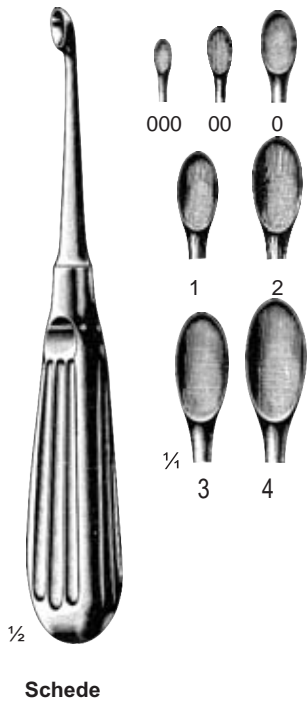

**Schede**

DC14-175-30  
DC14-175-20

DC14-175-10  
DC14-177-01  
DC14-177-02

DC14-177-03  
DC14-177-04

**Fig.**

0000  
000  
00

0  
1  
2  
3  
4  
5  
6

**Volkman**

DC14-179-40  
DC14-179-30  
DC14-179-20

DC14-179-10  
DC14-181-01  
DC14-181-02

DC14-181-03  
DC14-181-04  
DC14-181-05  
DC14-181-06

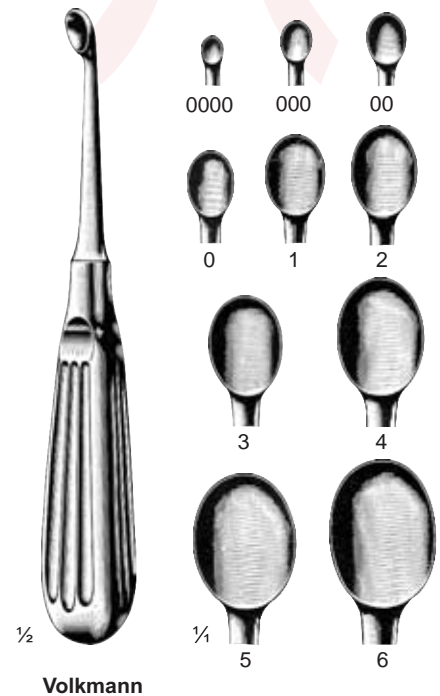

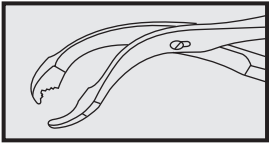

Bone Curettes



**Mod. USA**  
16 cm / 6¼"

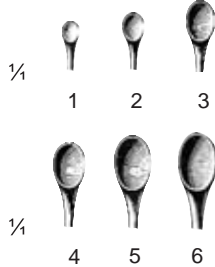
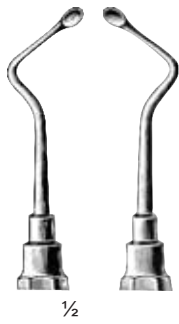
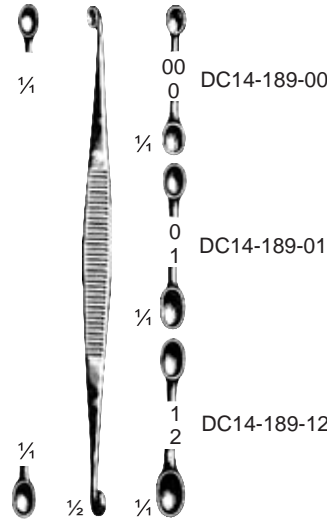
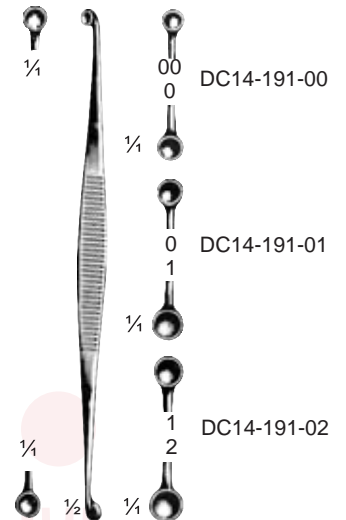

Fig.	straight	right curved	left curved
1	DC14-183-01	DC14-185-01	DC14-187-01
2	DC14-183-02	DC14-185-02	DC14-187-02
3	DC14-183-03	DC14-185-03	DC14-187-03
4	DC14-183-04	DC14-185-04	DC14-187-04
5	DC14-183-05	DC14-185-05	DC14-187-05
6	DC14-183-06	DC14-185-06	DC14-187-06



**Williger**  
13.5 cm / 5¼"



**Martini**  
13.5 cm / 5¼"

ACMA INTERNATIONAL



**Williger**  
17.5 cm / 7"

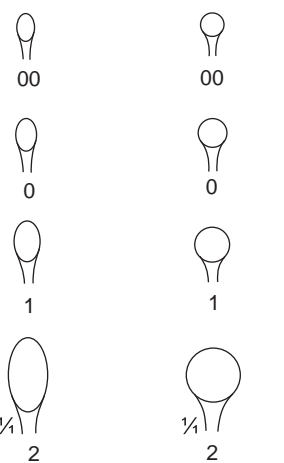
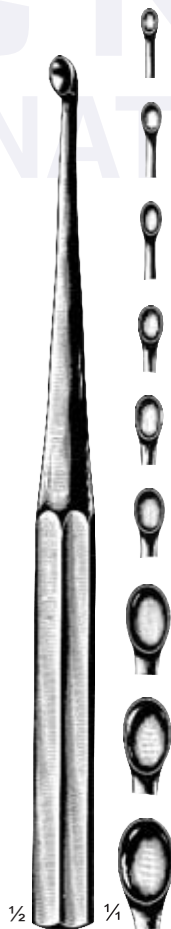

Fig.	straight, oval	straight, round
DC14-193-20	00	DC14-197-20
DC14-193-10	0	DC14-197-10
DC14-195-01	1	DC14-199-01
DC14-195-02	2	DC14-199-02



**Bruns**  
23 cm / 9"

- DC14-201-30
- DC14-201-20
- DC14-201-10
- DC14-201-01
- DC14-201-02
- DC14-201-03
- DC14-201-04
- DC14-201-05
- DC14-201-06



**DC14-203-25**  
25 cm / 9¾"



DC14-205-25  
25 cm / 9¾"

DC14-207-25  
25 cm / 9¾"



**Simon**  
24 cm / 9½"

- DC14-209-01
- DC14-209-02
- DC14-209-03
- DC14-209-04
- DC14-209-05
- DC14-209-06

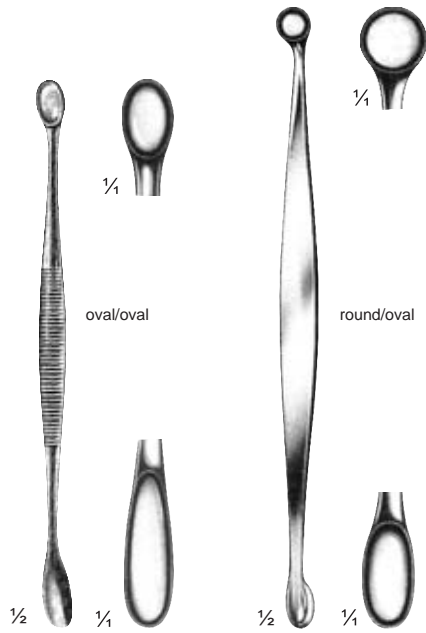
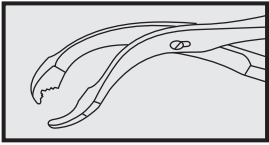

**Volkmann**

**Volkmann**

cm	inch		
13	5	DC14-211-13	DC14-213-13
14.5	5 1/2	DC14-211-14	
16	6 1/4		DC14-213-16
17	6 3/4	DC14-211-17	
20	8	DC14-211-20	DC14-213-20



**Wolff**  
14 cm/5 1/2"

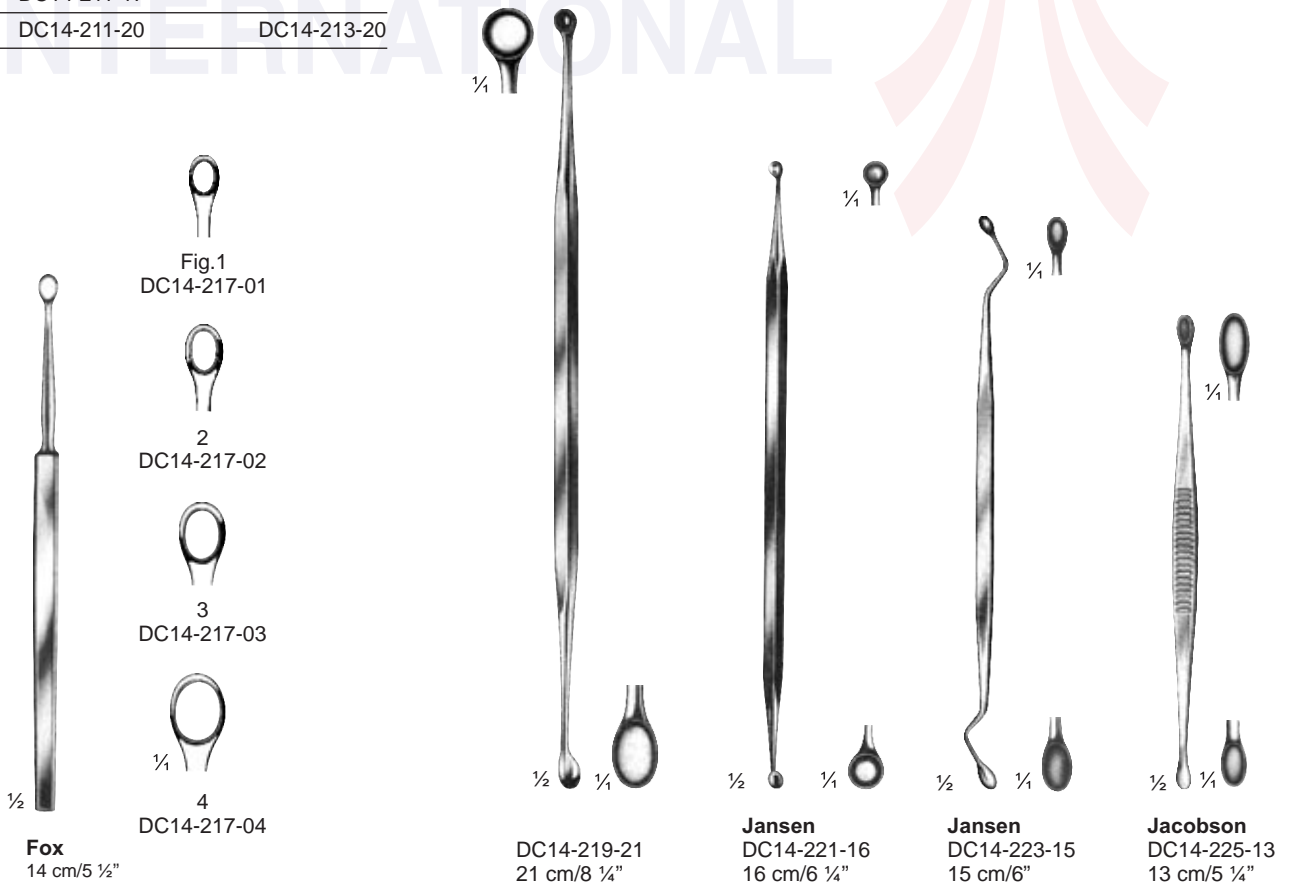
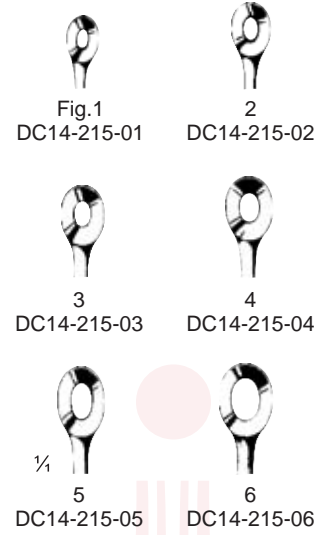

**Fox**  
14 cm/5 1/2"

**Jansen**  
DC14-219-21  
21 cm/8 1/4"

**Jansen**  
DC14-221-16  
16 cm/6 1/4"

**Jansen**  
DC14-223-15  
15 cm/6"

**Jacobson**  
DC14-225-13  
13 cm/5 1/4"

Bone Rongeurs

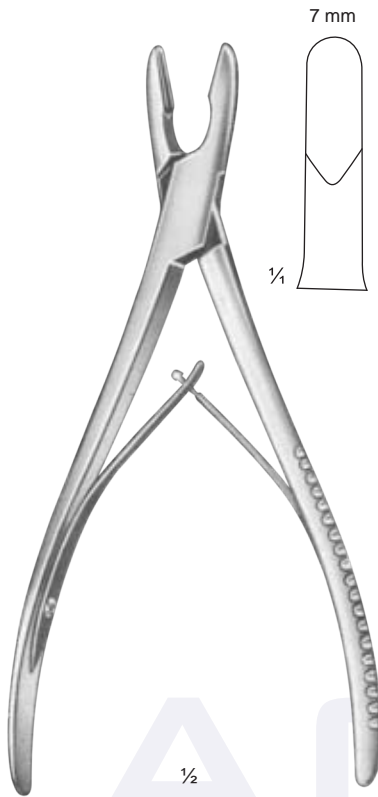
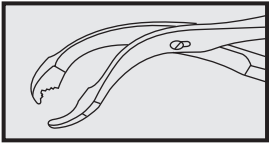

**Adson**  
DC14-227-20  
20cm/8"

Laminectomy Rongeurs



19cm/7½"



24cm/9½"



24cm/9½"

	straight		light curve		strong curve	
	3mm	4mm	3mm	4mm	3mm	4mm
<b>Smith-Peterson</b>						
19cm/7½"	DC14-229-03	DC14-229-04	DC14-229-13	DC14-229-14	DC14-229-23	DC14-229-24
24cm/9½"	DC14-231-03	DC14-231-04	DC14-231-13	DC14-231-14	DC14-231-23	DC14-231-24
<b>Fulton</b>	5mm	6mm	5mm	6mm	5mm	6mm
19cm/7½"	DC14-229-05	DC14-229-06	DC14-229-15	DC14-229-16	DC14-229-25	DC14-229-26
24cm/9½"	DC14-231-05	DC14-231-06	DC14-231-15	DC14-231-16	DC14-231-25	DC14-231-26



Bone Rongeur Forceps

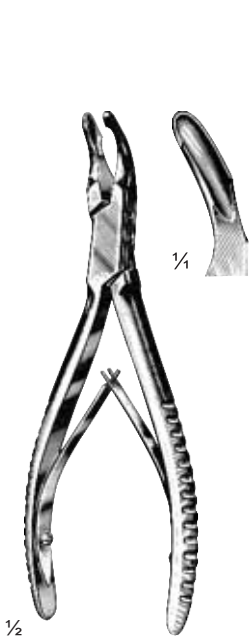
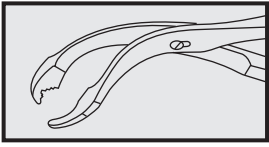

**Cleveland**  
DC14-233-14  
14 cm/5 1/2"

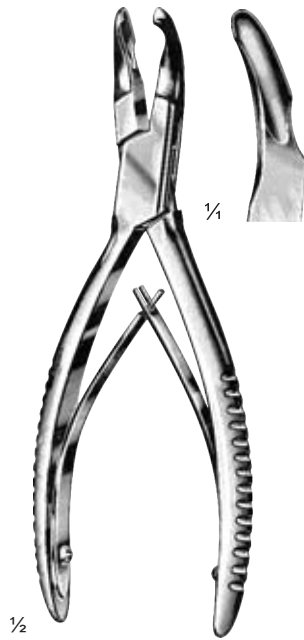

**Cleveland**  
DC14-235-17  
17 cm/6 3/4"

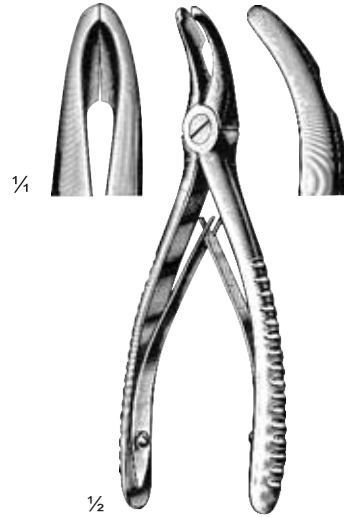

**Universal**  
DC14-237-13  
13.5 cm/5 1/4"

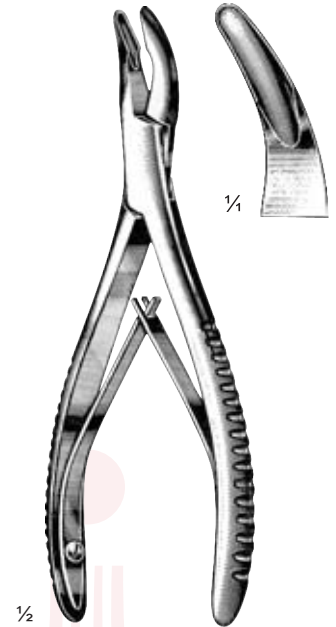

**Mead**  
DC14-239-16  
16.5 cm/6 1/2"

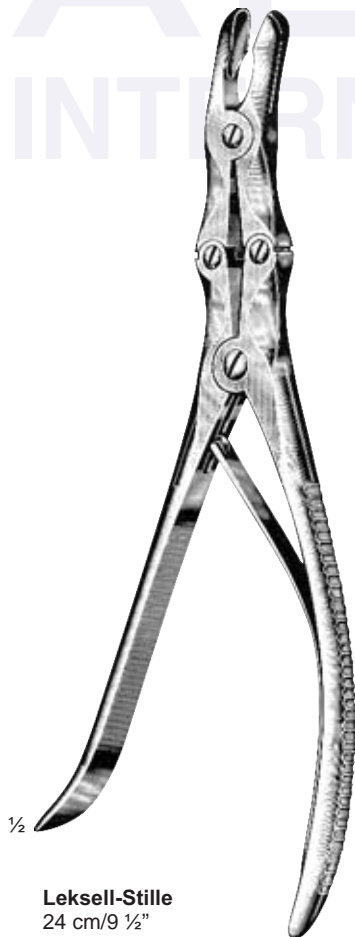

**Leksell-Stille**  
24 cm/9 1/2"

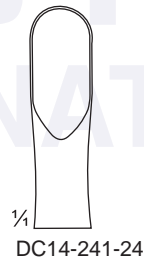

DC14-241-24

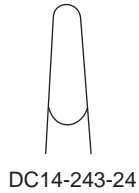

DC14-243-24

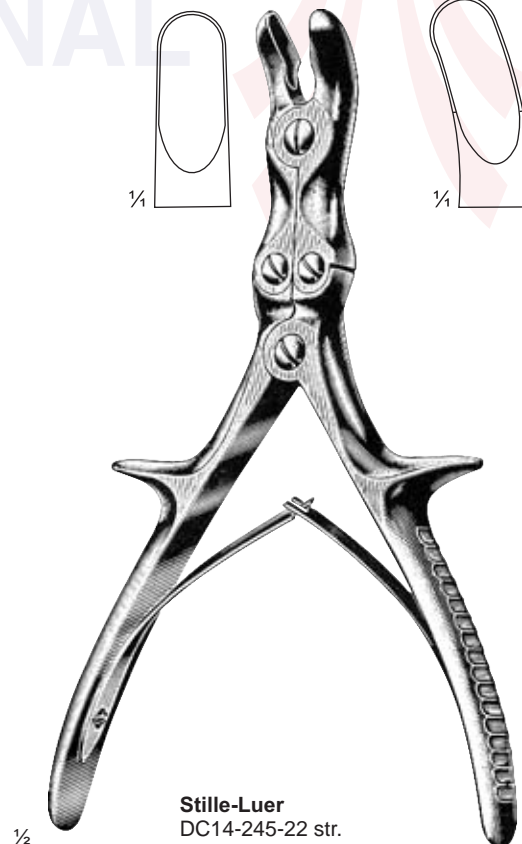

**Stille-Luer**  
DC14-245-22 str.  
DC14-247-22 cvd.  
22cm/8 3/4"



DC14-245-22 str.



DC14-247-22 cvd.

Bone Rongeur Forceps

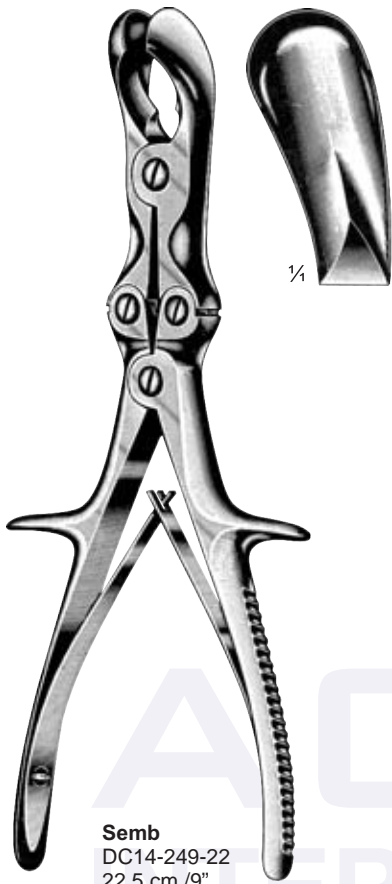
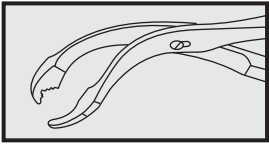

**Semb**  
DC14-249-22  
22.5 cm / 9"

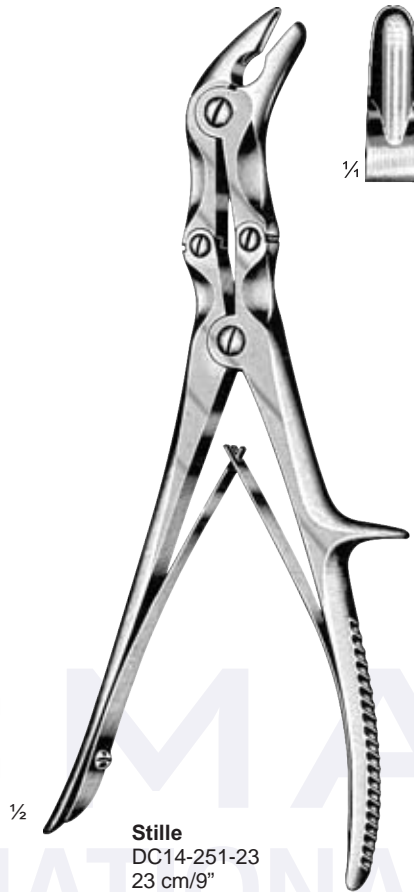

**Stille**  
DC14-251-23  
23 cm / 9"

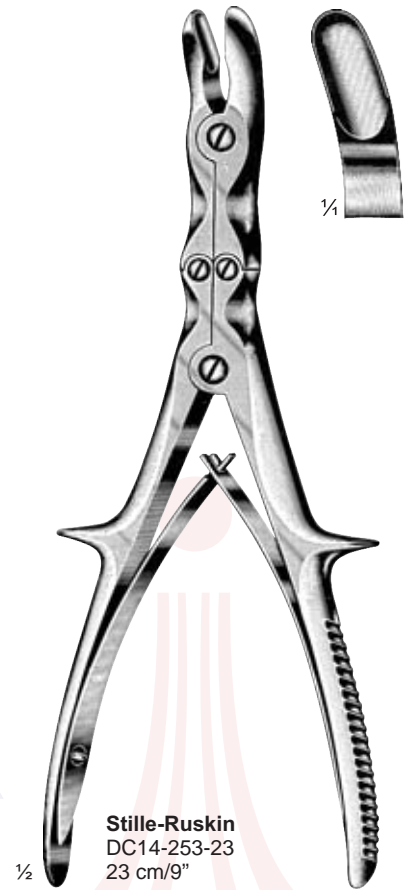

**Stille-Ruskin**  
DC14-253-23  
23 cm / 9"

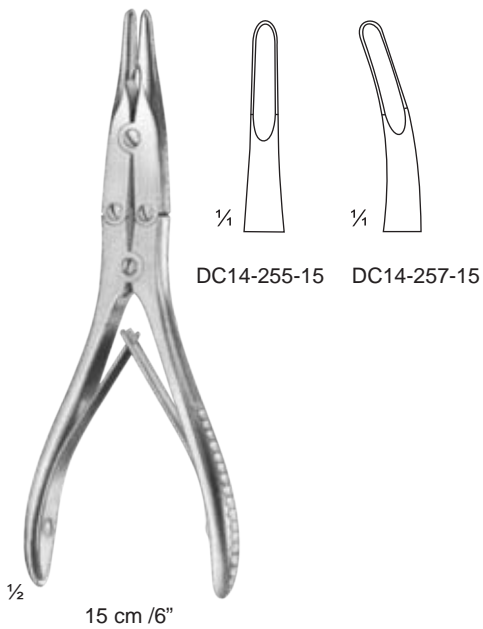

DC14-255-15 DC14-257-15



**Beyer**  
DC14-259-18  
18 cm / 7"



**Zaufal-Jansen**  
DC14-261-18  
18 cm / 7"

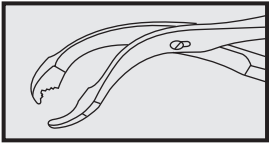

Bone Rongeur Forceps



DC14-263-23  
23cm/9"  
DC14-263-27  
27cm/10 1/2"



Stille-Luer



DC14-265-23  
23cm/9"  
DC14-265-27  
27cm/10 1/2"

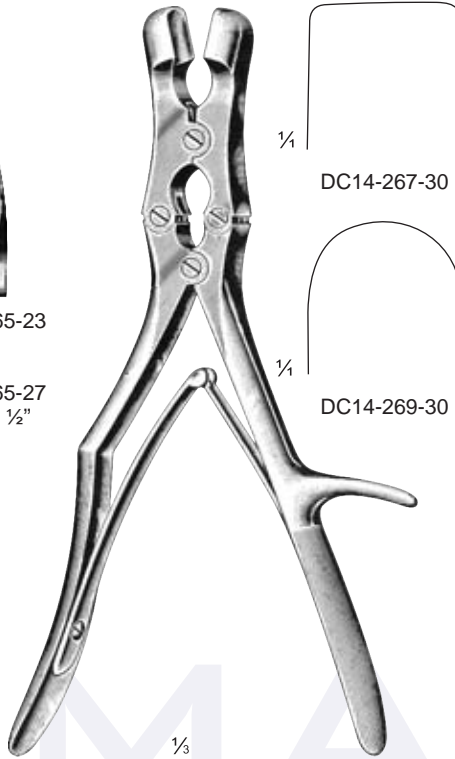

Sauerbruch  
30 cm /12"

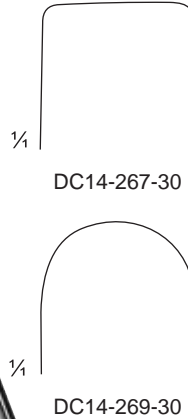

DC14-267-30

DC14-269-30

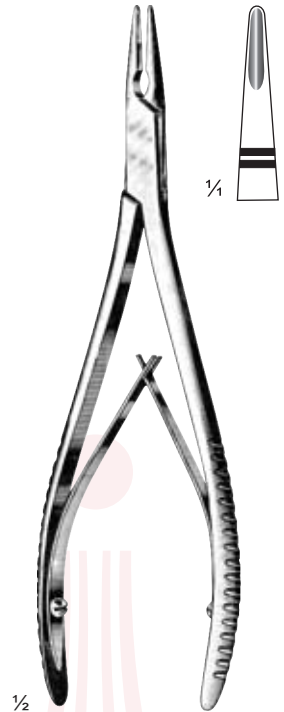

Lempert  
DC14-271-19  
19 cm/7 1/2"

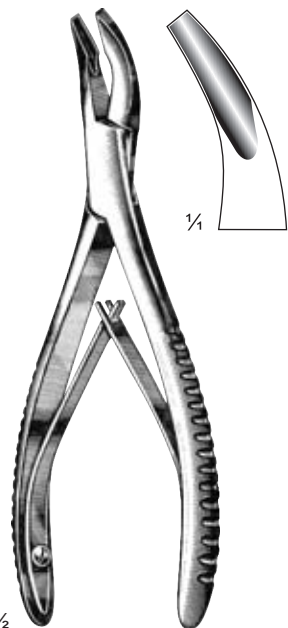

Mead  
DC14-273-16  
16.5 cm/6 1/2"

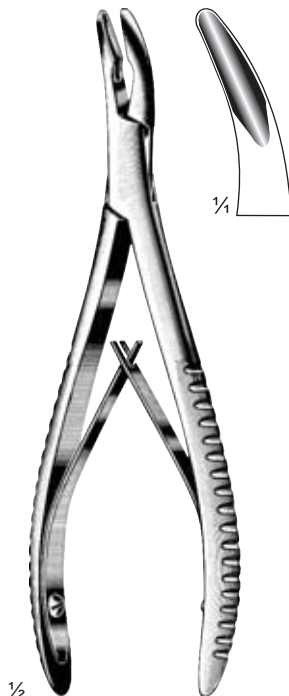

Hartmann  
DC14-275-18  
18.5 cm/7 1/4"

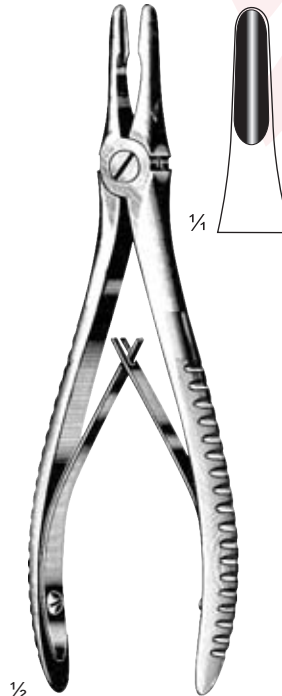

Jansen  
DC14-277-18  
18 cm/7"

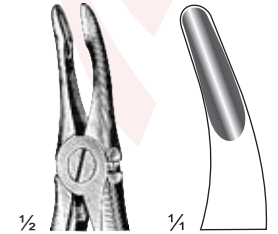

DC14-279-18

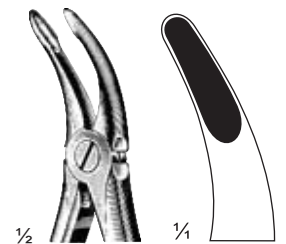

DC14-281-18

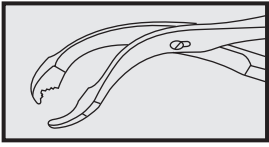

Bone Rongeur Forceps



**Ruskin**  
DC14-283-23  
23 cm / 9"

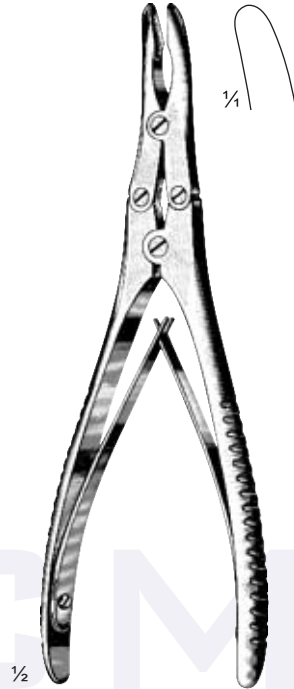

**Ruskin**  
DC14-285-18  
18 cm / 7"



**Stellbrink**  
17 cm / 6 3/4"

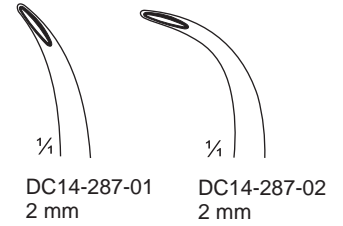

DC14-287-01  
2 mm

DC14-287-02  
2 mm

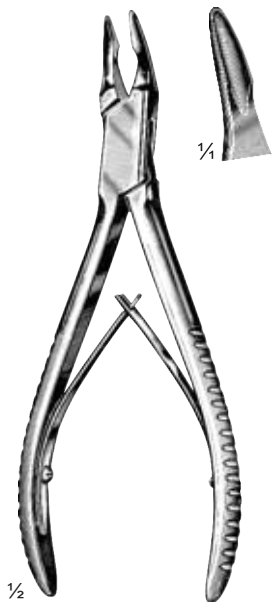

**Blumenthal**  
DC14-289-15  
15.5 cm / 6"



**Blumenthal**  
DC14-291-15  
15.5 cm / 6"



**Friedman**  
DC14-293-14  
14 cm / 5 1/2"



**Mini-Friedman**  
DC14-295-12  
12 cm / 5"

Bone Rongeur Forceps

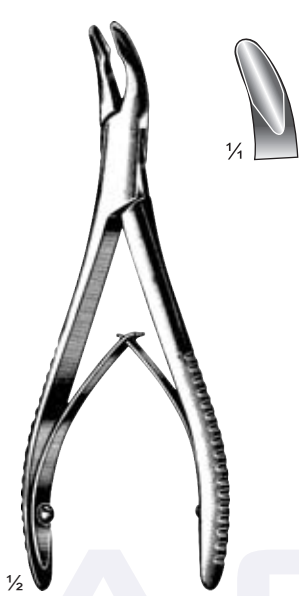
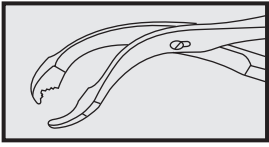

**Luer**  
DC14-297-15  
15 cm/6"

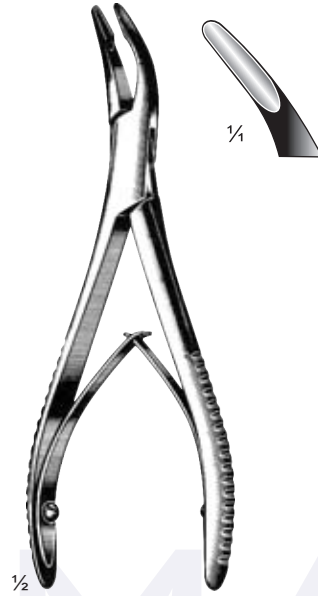

**Luer**  
DC14-299-15  
15 cm/6"

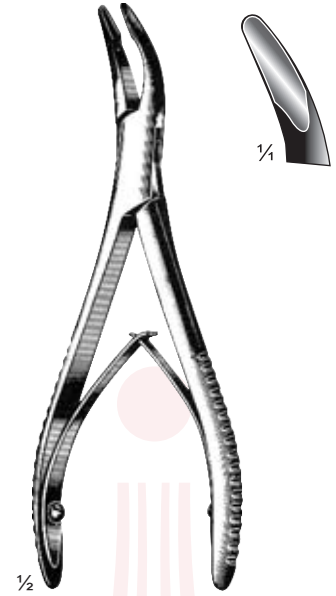

**Luer**  
DC14-301-15  
15 cm/6"



DC14-303-18  
18 cm/7"

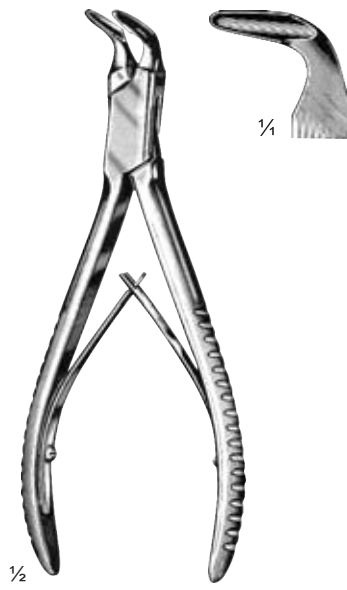

**Blumenthal**  
DC14-305-15  
15.5 cm/6"

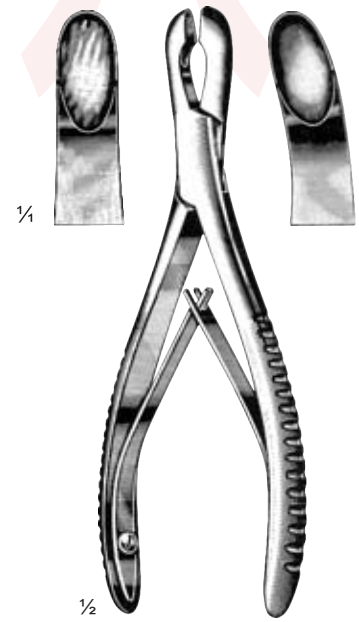

**Luer**  
DC14-307-17 str.  
DC14-309-17 cvd.  
17 cm/6 3/4"

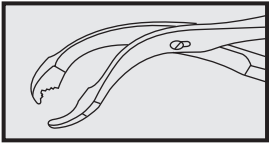

Bone Cutting Forceps

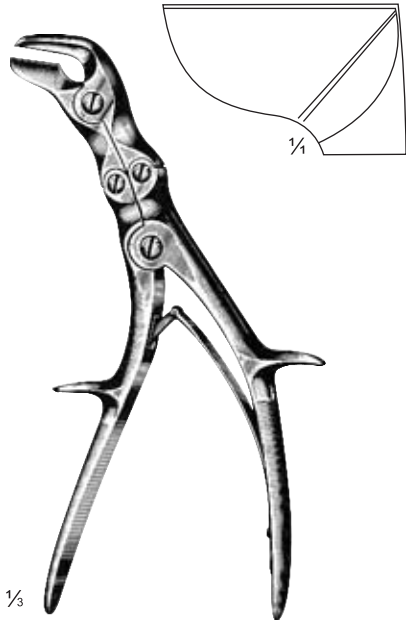

**Semb**  
DC14-311-24  
24 cm/9 1/2"

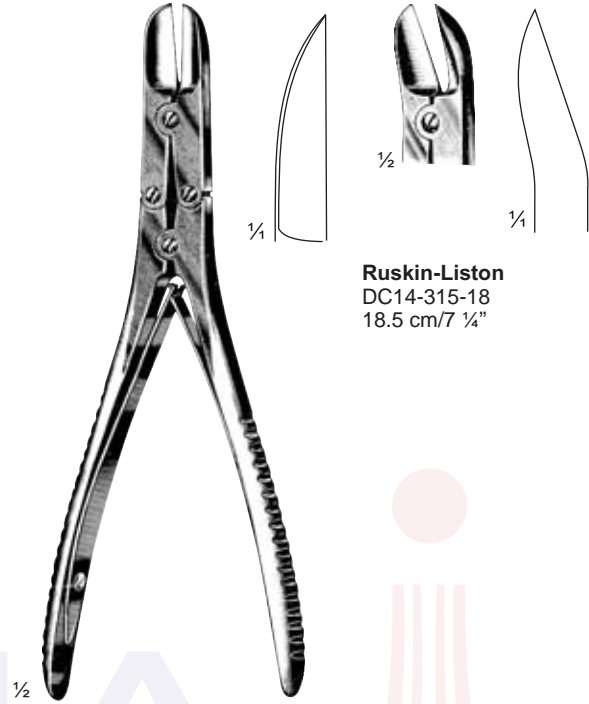

**Ruskin-Liston**  
DC14-315-18  
18.5 cm/7 1/4"

**Ruskin-Liston**  
DC14-313-18  
18.5 cm/7 1/4"

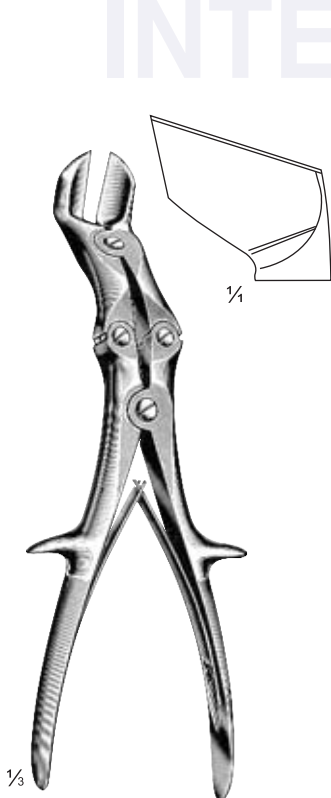

**Liston-Key**  
DC14-317-27  
27 cm/10 1/2"

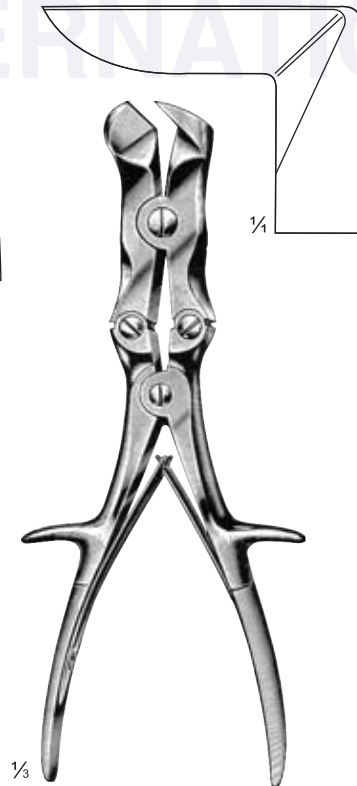

**Stille-Liston**  
DC14-319-27  
27 cm/10 1/2"

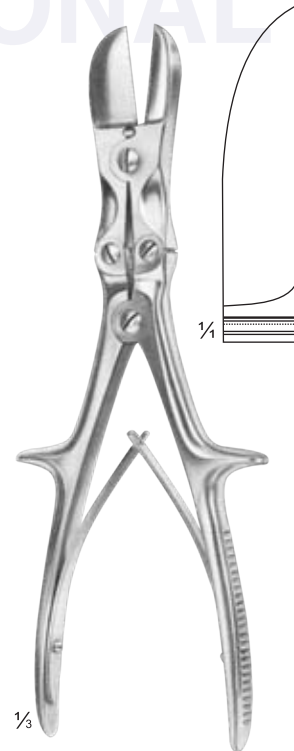

**Stille-Liston**  
DC14-321-27  
27 cm/10 1/2"

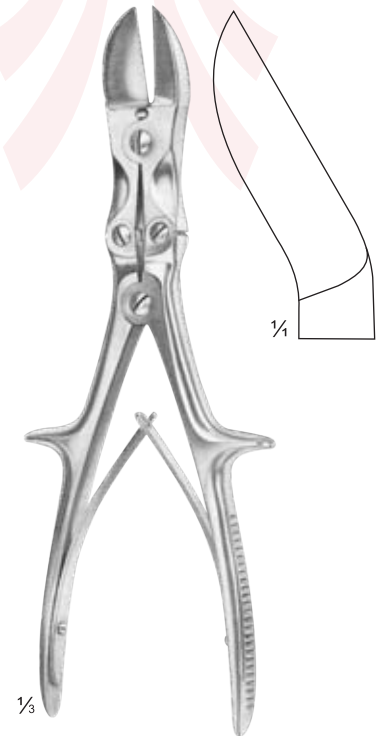

**Stille-Liston**  
DC14-323-27  
27 cm/10 1/2"

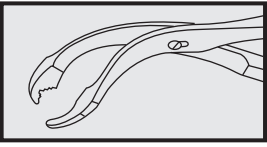

Bone Cutting Forceps, Bone Perforating Forceps



DC14-325-15  
15 cm/5 3/4"

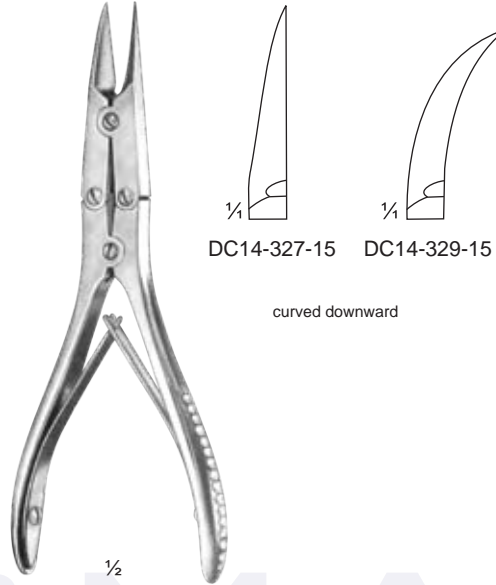

DC14-327-15 DC14-329-15

curved downward

1/2  
15 cm/5 3/4"



DC14-331-12  
12 cm/4 3/4"

ACMA  
INTERNATIONAL

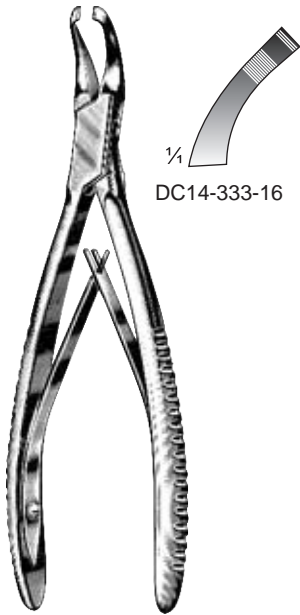

DC14-333-16

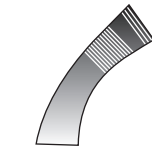

DC14-335-16

1/2  
**Cleveland**  
16 cm/6 1/4"

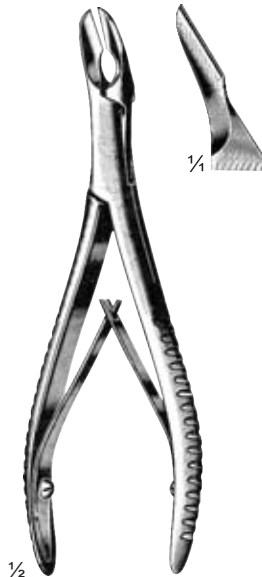

1/2  
**Cleveland**  
DC14-337-15  
15 cm/6"

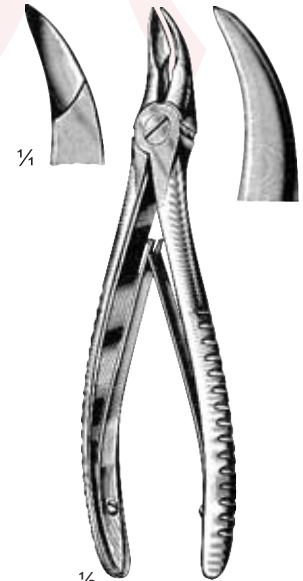

1/2  
DC14-339-15  
15 cm/6"

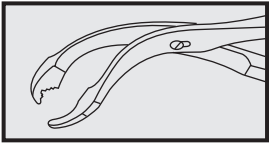

Bone Cutting Forceps, Lead Hands

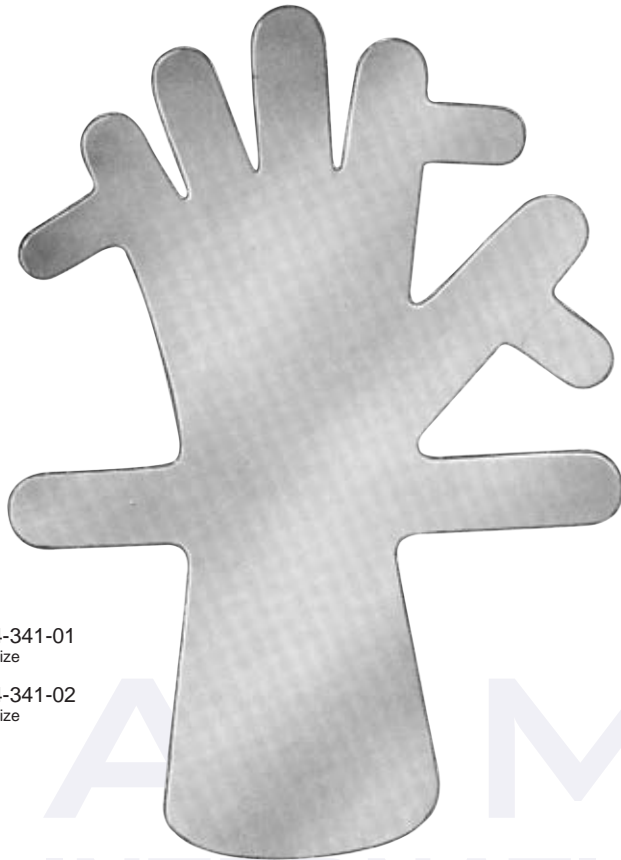

DC14-341-01  
Child Size

DC14-341-02  
Adult Size

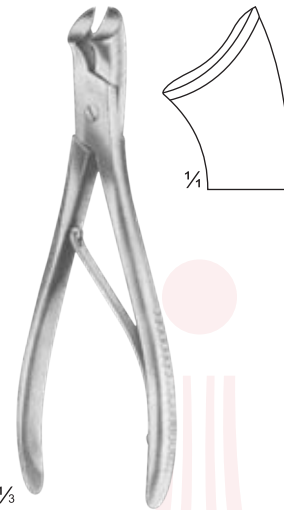

Markwalder  
DC14-343-20  
20 cm / 8"

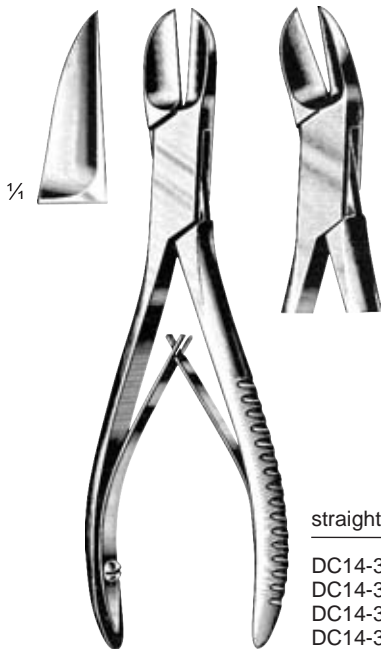

Liston

	straight	cm	in.	curved
	DC14-345-14	14	5½	DC14-347-14
	DC14-345-17	17	6¾	DC14-347-17
	DC14-345-19	19	7½	DC14-347-19
	DC14-345-22	22	8¾	DC14-347-22



Cleveland  
DC14-349-17  
17 cm / 6 ¾"

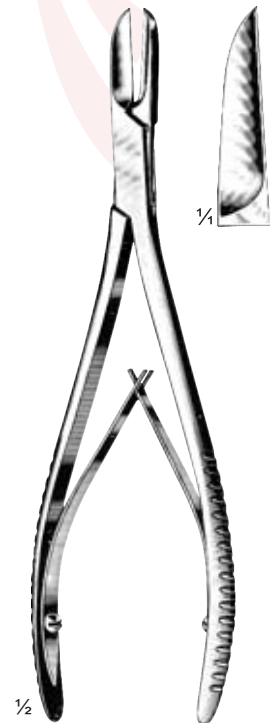

Cottle Kazanjian  
DC14-351-19  
19 cm / 7 ½"



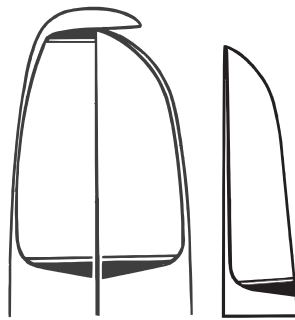
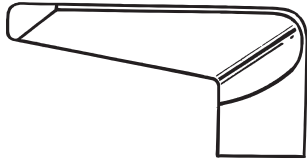
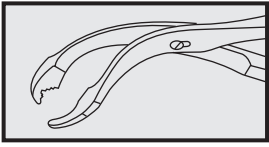

For the left hand

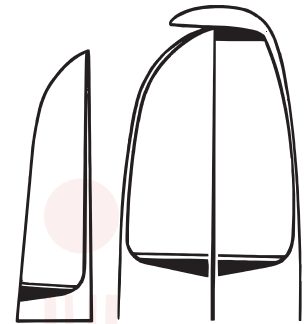

For the right hand



**Roos**  
DC14-357-33  
33cm/13"



**Coryllos-Bethune**  
DC14-359-35  
35cm/13 3/4"



**Coryllos-Bethune**  
DC14-361-35  
35cm/13 3/4"

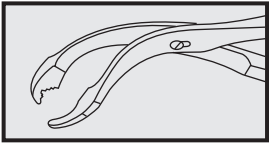

Rib Shears, Sternum Shears



1/4  
**Stille-Giertz**  
DC14-363-25  
24.5cm/9 3/4"



1/4  
**Sauerbruch**  
DC14-365-23 = 23cm/9"  
DC14-365-26 = 26cm/10 1/4"

ACMA  
INTERNATIONAL

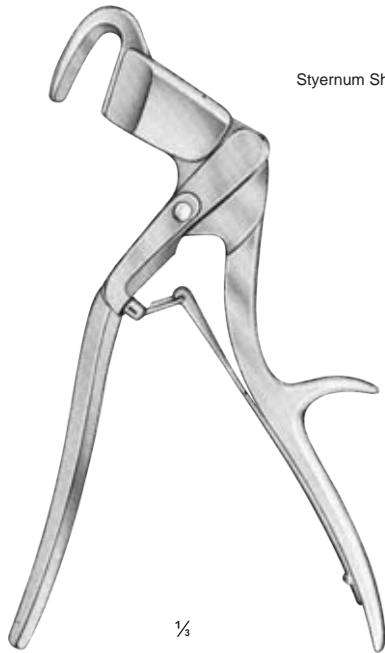
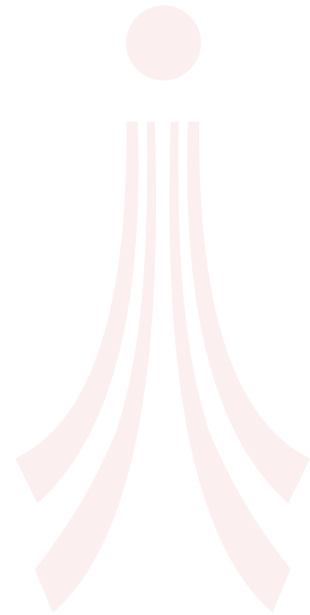

Sternum Shears

1/4  
**Lebsche**  
DC14-373-25  
25cm/10"



With eccentric  
sliding blade

**Gluck**  
DC14-375-19 = 19cm/7 1/2"  
DC14-375-22 = 22cm/8 3/4"

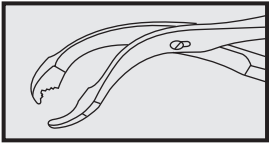

Pin Cutters, Wire Cutters

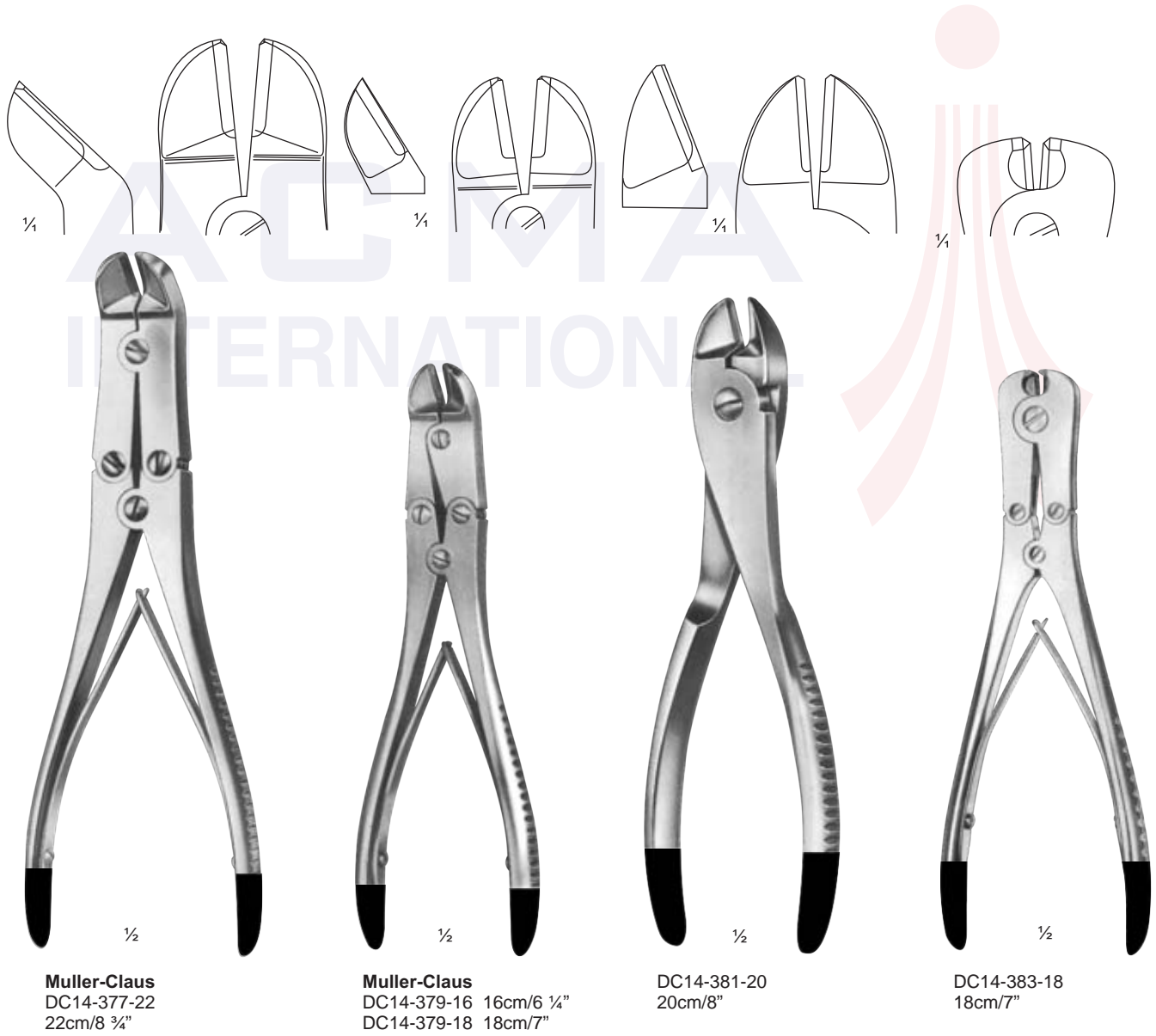

**Muller-Claus**  
DC14-377-22  
22cm/8 3/4"

**Muller-Claus**  
DC14-379-16 16cm/6 1/4"  
DC14-379-18 18cm/7"

DC14-381-20  
20cm/8"

DC14-383-18  
18cm/7"

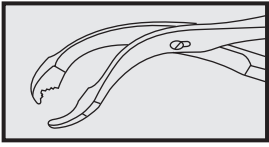

Wire Pullers, Flat Pliers, Wire Twisters



Mayo-Hauberisser



1/4

DC14-385-17  
17cm/6 3/4"



DC14-385-20  
20cm/8"

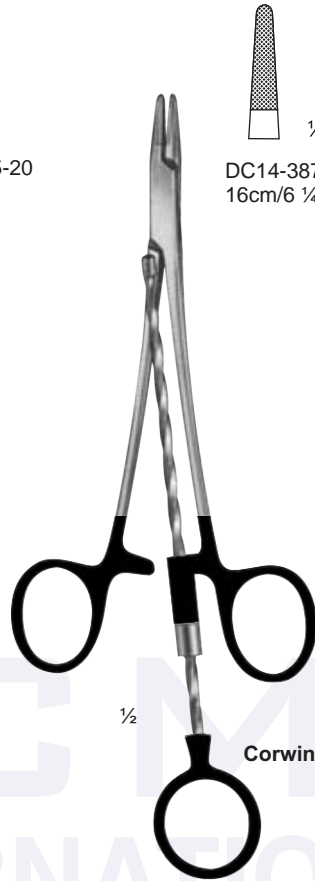

1/2



1/4

DC14-387-16  
16cm/6 1/4"



DC14-389-16  
16cm/6 1/4"



DC14-391-16  
16cm/6 1/4"

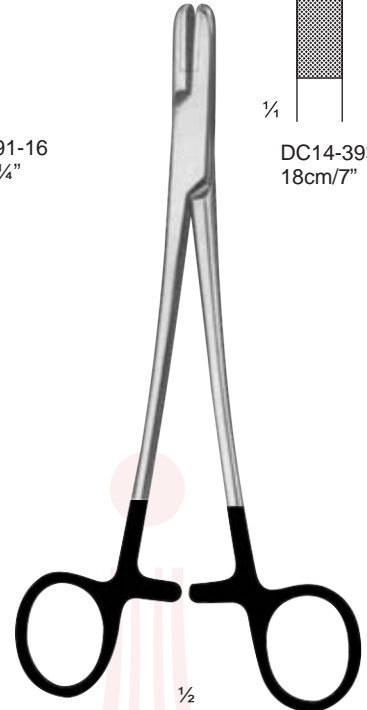

1/2

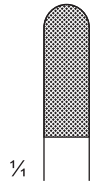

1/4

DC14-393-18  
18cm/7"

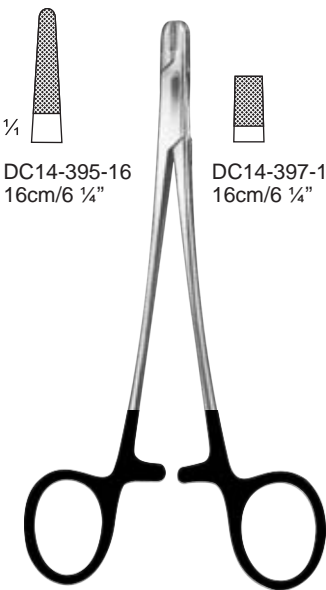

Mayo-Hauberisser

1/4

DC14-395-16  
16cm/6 1/4"



DC14-397-16  
16cm/6 1/4"



DC14-399-16  
16cm/6 1/4"



1/2

2mm

1/4

DC14-401-18  
18cm/7"

4mm

1/4

DC14-403-18  
18cm/7"

6mm

1/4

DC14-405-18  
18cm/7"

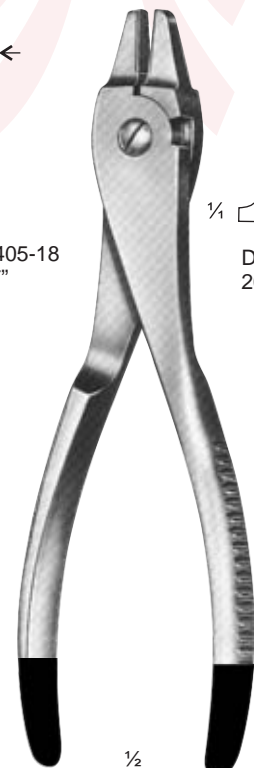

1/2

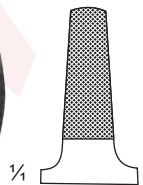

1/4

DC14-407-20  
20cm/8"

Bone Holding Forceps

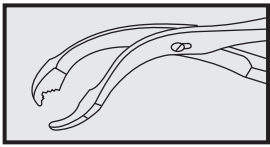

DC14-409-14  
13.5 cm / 5 1/4"

**Langenbeck**  
DC14-411-21  
21 cm / 8 1/4"

**Fergusson**  
DC14-413-21  
21 cm / 8 1/4"

**Frosch**  
DC14-415-18  
18 cm / 7"

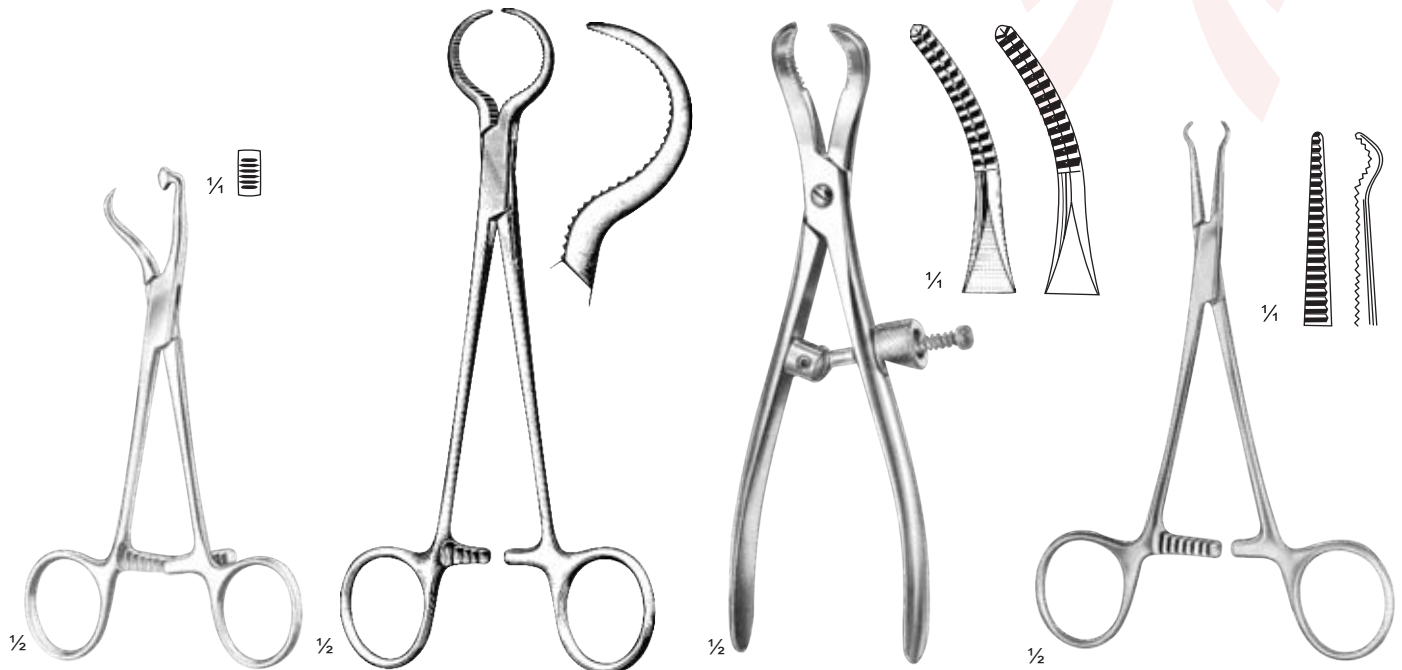

DC14-417-12  
12 cm / 4 3/4"

**Lewin**  
DC14-419-17  
17.5 cm / 7"

DC14-421-16  
16 cm / 6 1/4"

DC14-423-14  
14 cm / 5 1/2"

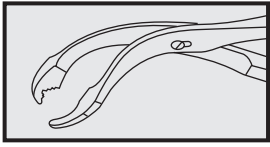

Bone Holding Forceps



**Bunnell-Howard**  
DC14-425-15  
15 cm / 6"

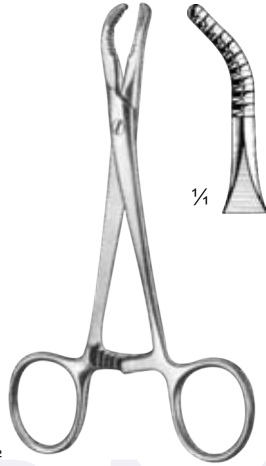

DC14-427-14  
13.5 cm / 5 1/4"

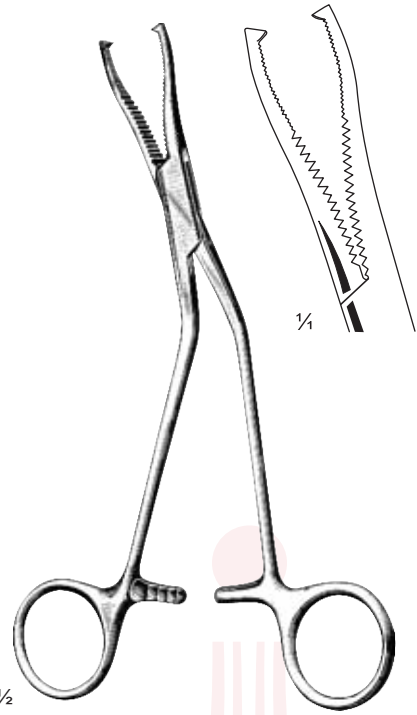

**Dingmann**  
DC14-429-19  
19 cm / 7 1/2"

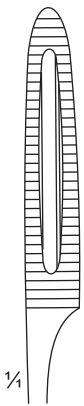

DC14-433-20  
straight



20 cm / 8"

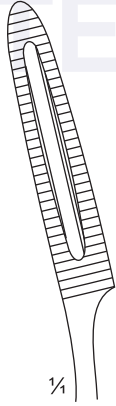

DC14-435-20  
curved-on flat

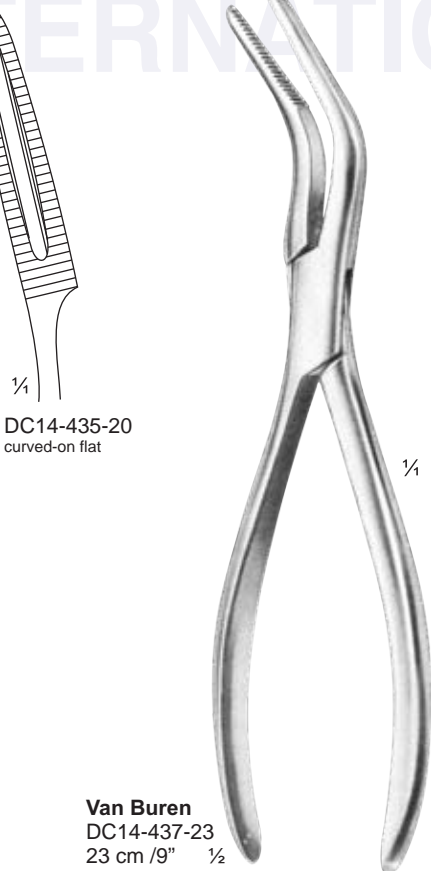

**Van Buren**  
DC14-437-23  
23 cm / 9" 1/2

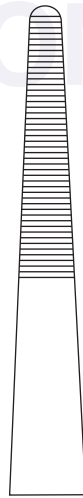

1/2

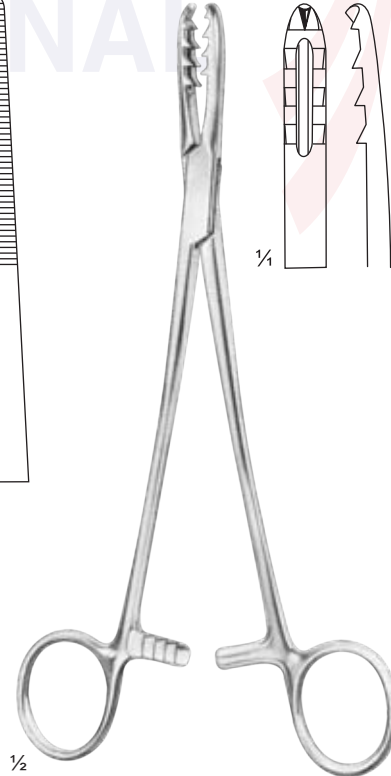

**Bircher-Ganske**  
DC14-439-20  
20 cm / 8"



1/4



1/2



1/4

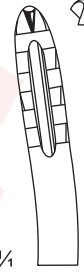

**Bircher-Ganske**  
DC14-441-20  
20 cm / 8"

Bone Holding Forceps, Retractors

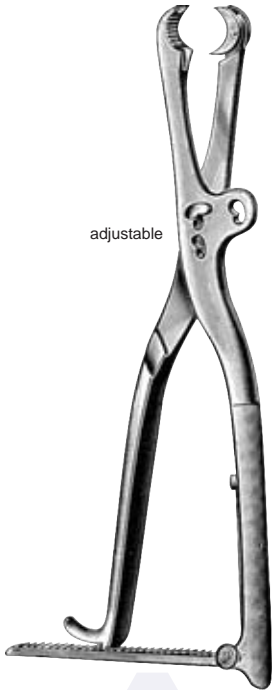
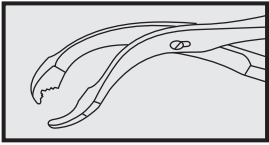

cm	in.	Lambotte
22	8 ¾	DC14-443-22
27	10 ½	DC14-443-27
30	12	DC14-443-30

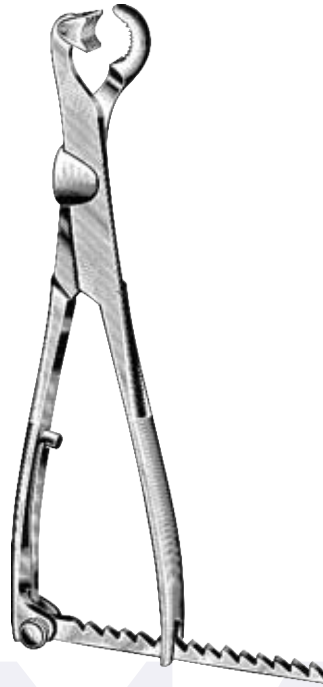

cm	in.	Lambotte
22	8 ¾	DC14-445-22
26	10 ¼	DC14-445-26
33	13	DC14-445-33

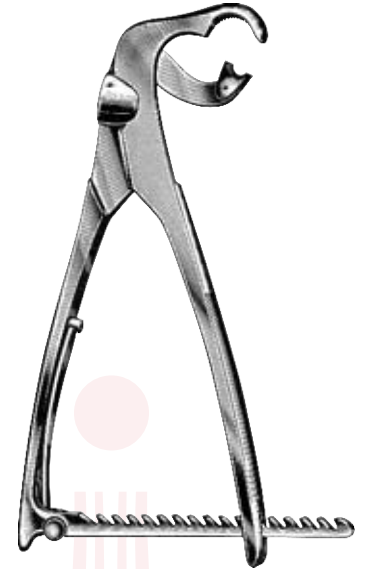

cm	in.	Lambotte
19	7 ½	DC14-447-19
23	9	DC14-447-23
26	10 ¼	DC14-447-26

ACMA INTERNATIONAL



**Verburgge**  
DC14-449-01  
17.5 cm/6 ¾"

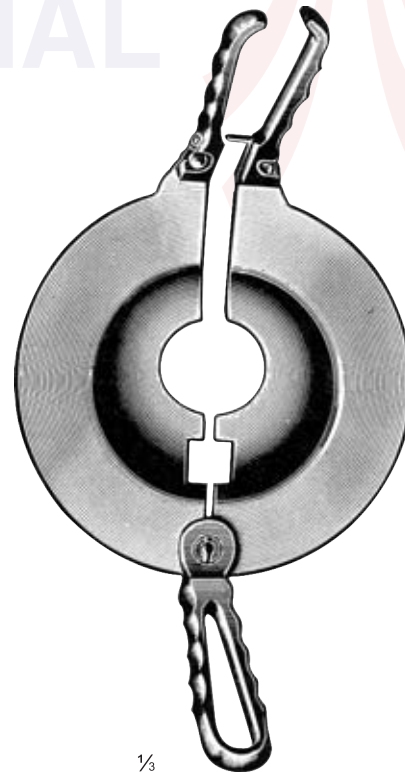

**Percy**  
DC14-451-30  
simple pattern, handles detachable

Bone Holding Forceps, Retractors

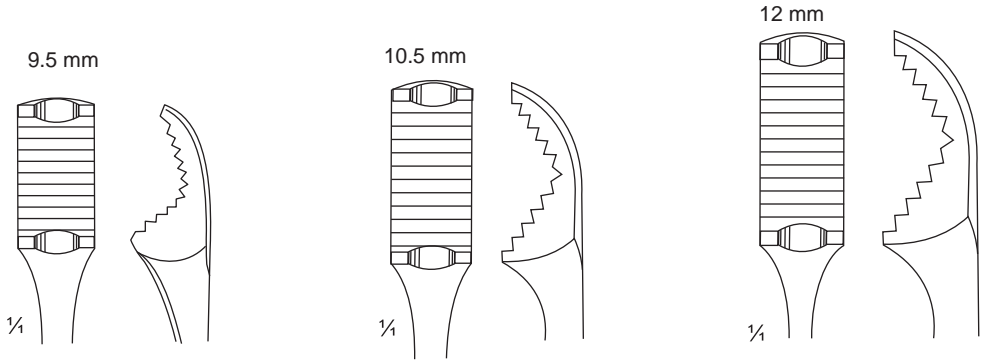
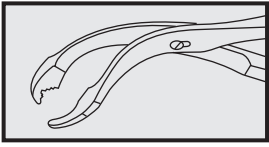

**Verburgge**  
DC14-453-25  
25 cm/10"

**Verburgge**  
DC14-453-26  
26 cm/10 1/2"

**Verburgge**  
DC14-453-27  
27 cm/11"



1/2  
**Verburgge**  
DC14-453-25 - 27

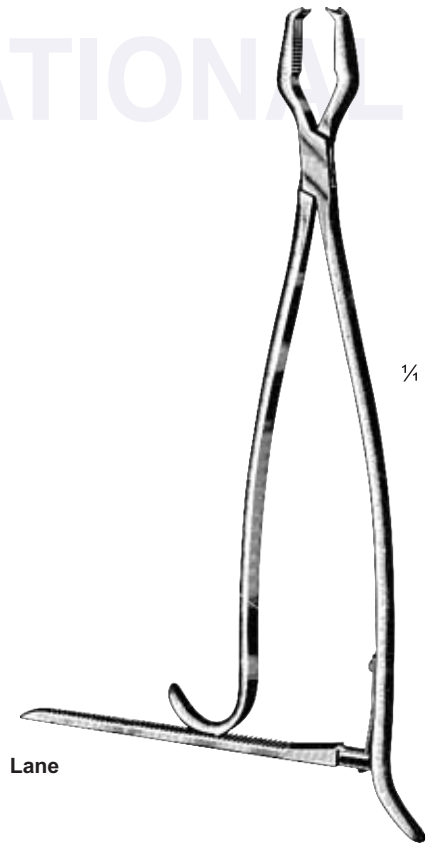

1/4  
DC14-455-33  
33 cm /13"  
with ratchet

DC14-457-33 = 33 cm/13"  
DC14-457-45 = 45 cm/17 3/4"  
without ratchet

Lane

ACMA  
INTERNATIONAL



Bone Holding Forceps

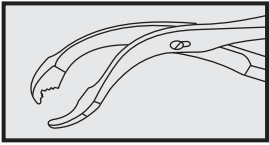

**Farabeuf**  
DC14-459-23 = 23 cm/9"  
DC14-459-26 = 26 cm/10 ¼"

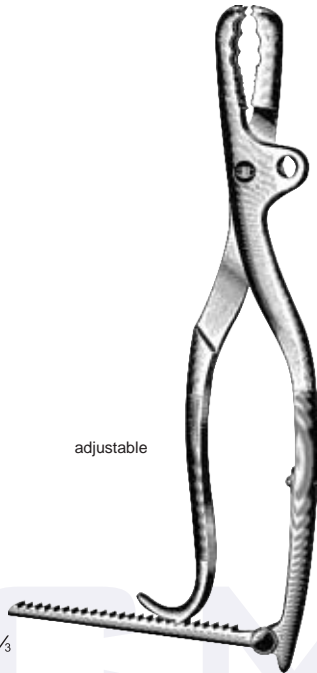

**Farabeuf-Lambotte**  
DC14-461-26  
26 cm/10 ¼"

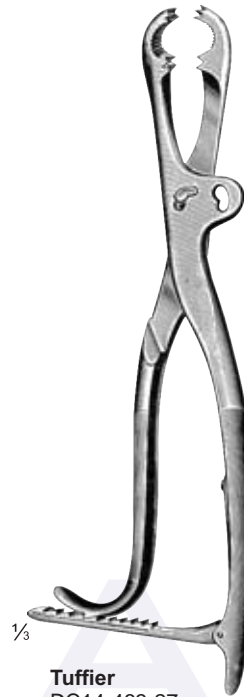

**Tuffier**  
DC14-463-27  
27 cm/10 ½"

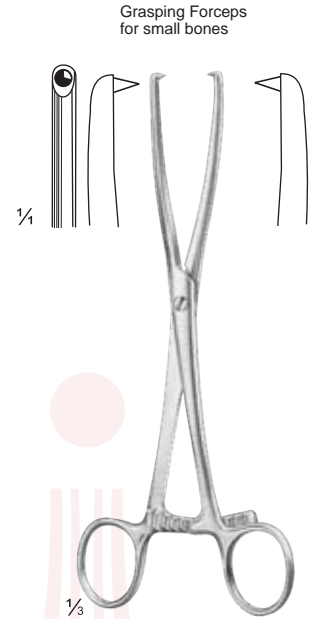

DC14-465-21  
21 cm/8 ¼"

INTERNATIONAL

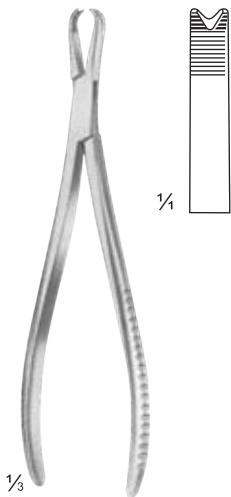

DC14-467-20  
20 cm /8"

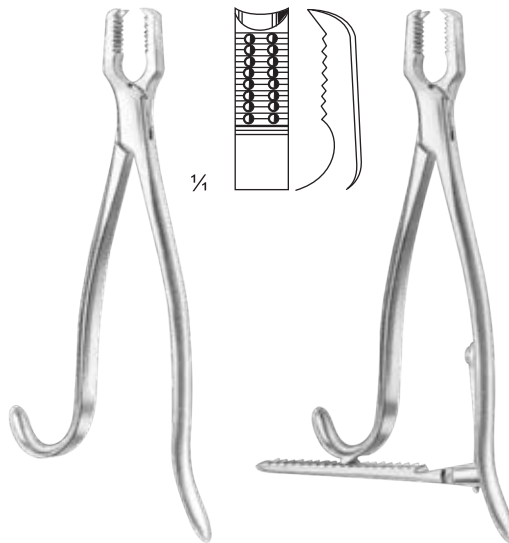

**Kern**

	without ratchet	cm	in.	with ratchet
DC14-469-17	17	6 ¾	DC14-471-17	
DC14-469-21	21	8 ¼	DC14-471-21	

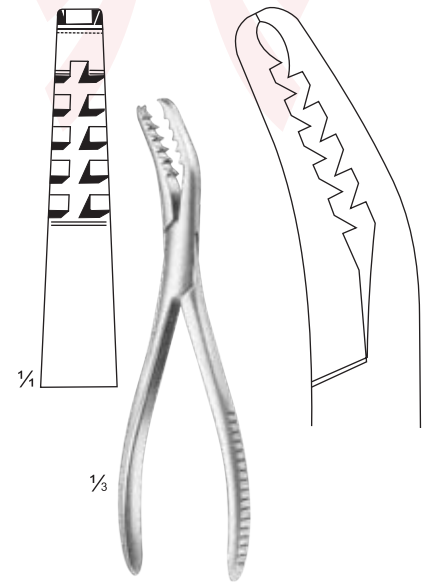

**Semb**  
DC14-473-19  
19 cm/7 ½"

Bone Holding Forceps

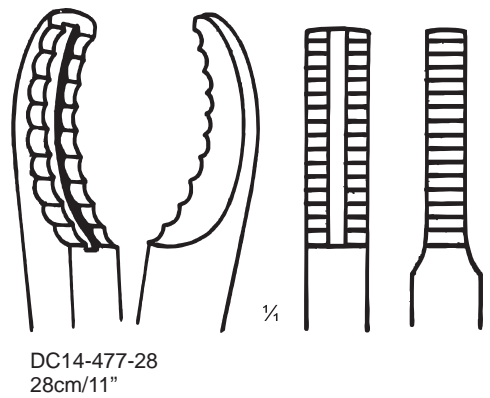
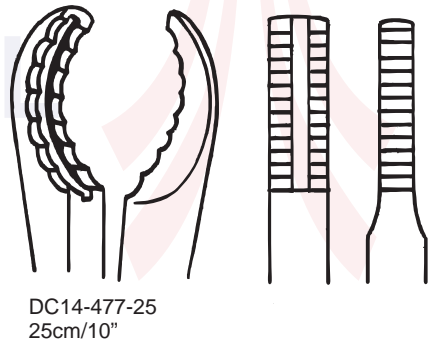
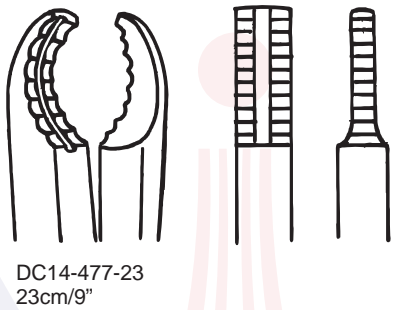
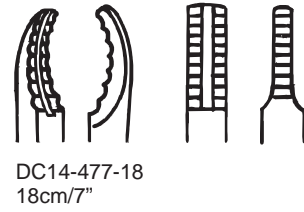
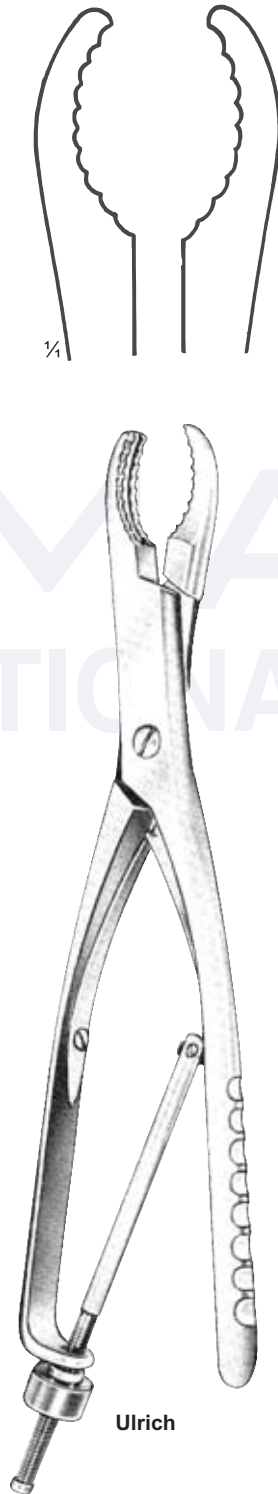
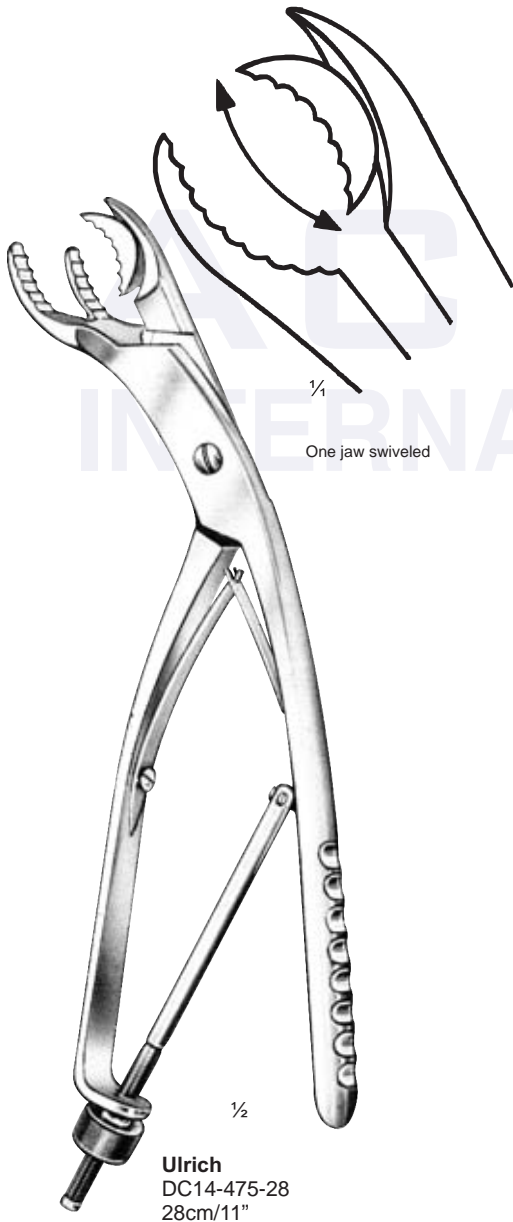
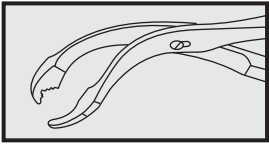

Bone Holding Forceps

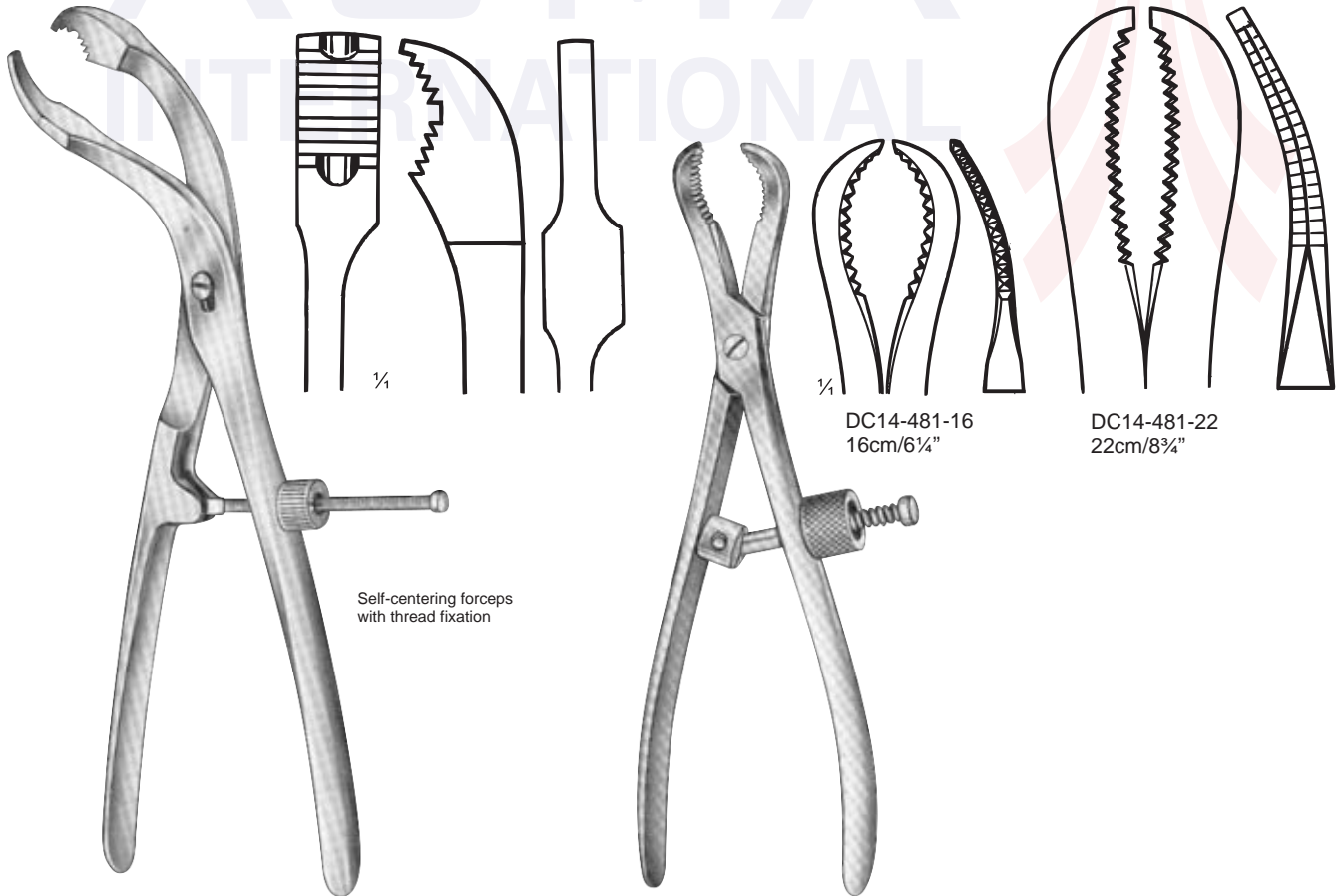
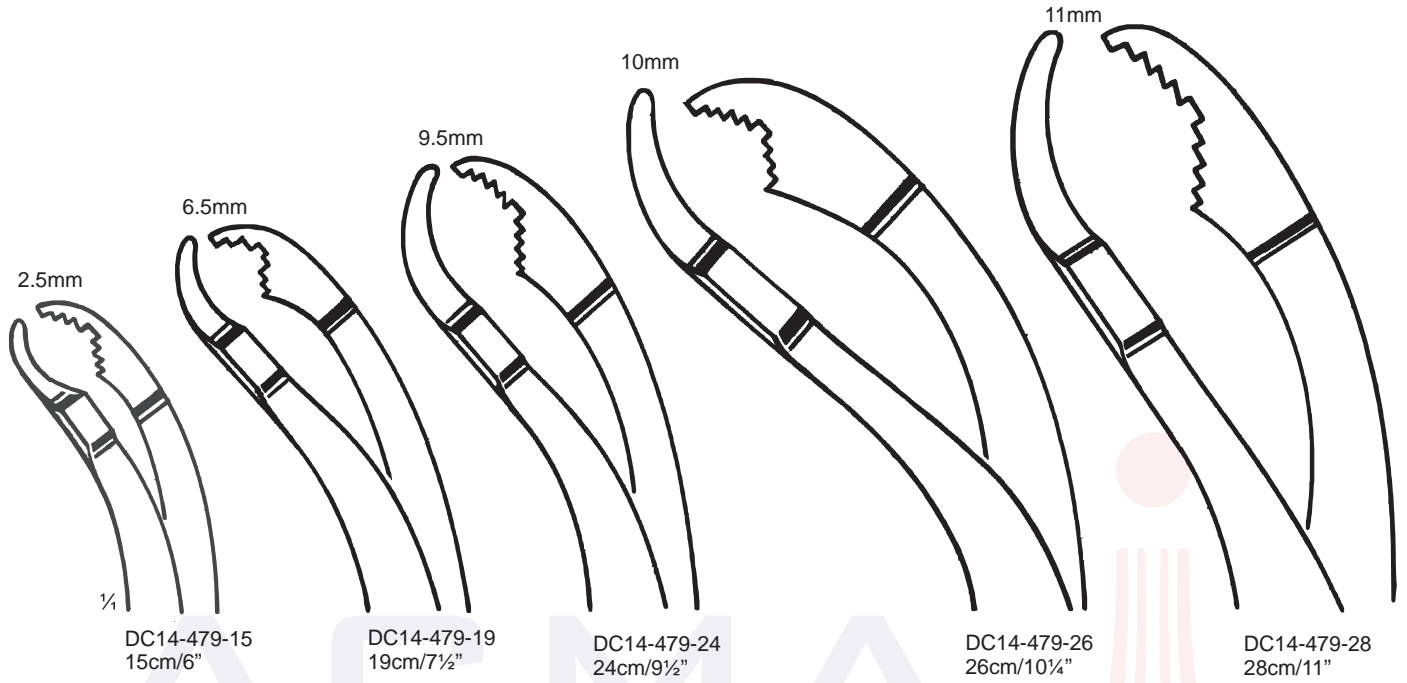
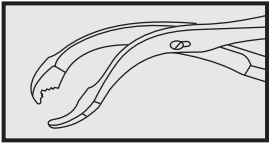

DC14-479-15 - DC14-479-28

Setter

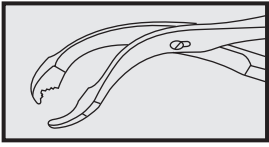

Raspatories with Ferrozell-Handle



DC14-483-19  
19cm/7 1/2"



DC14-485-18  
18.5cm/7 1/4"



DC14-487-18  
18.5cm/7 1/4"



DC14-489-18  
18.5cm/7 1/4"

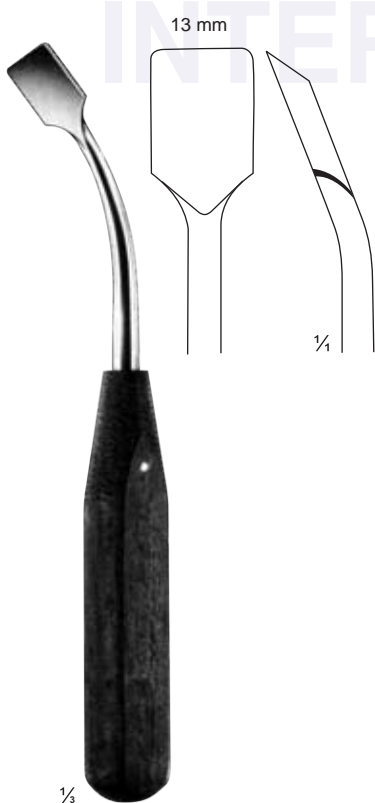

DC14-491-18  
18.5cm/7 1/4"



DC14-493-19  
19.5cm/7 3/4"

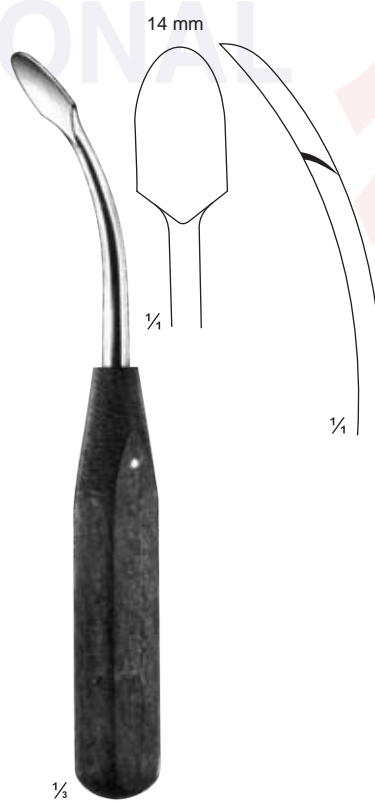

DC14-495-18  
18.5cm/7 1/4"

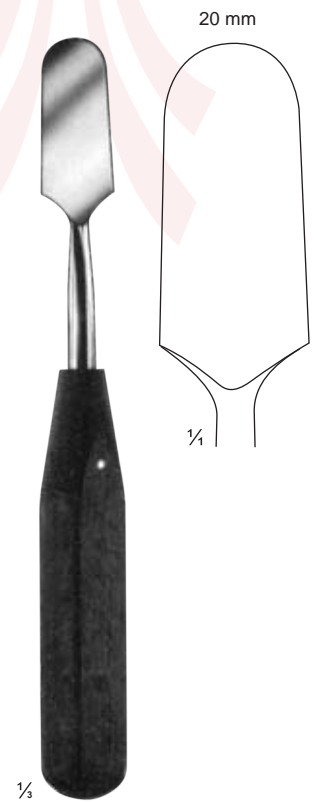

DC14-497-20  
20cm/8"

Raspatories

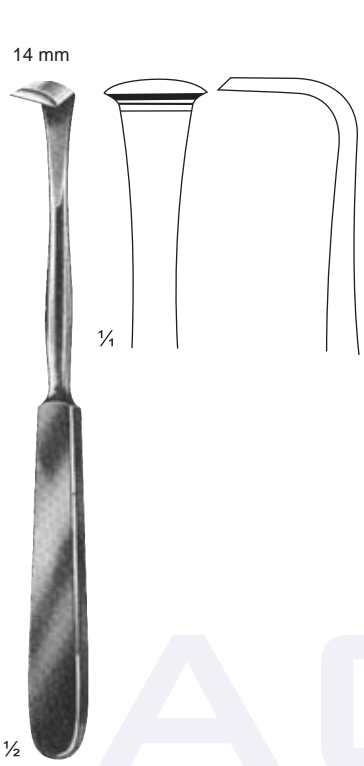
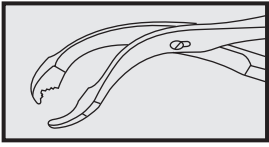

**Langenbeck**  
DC14-499-18  
18cm/7"

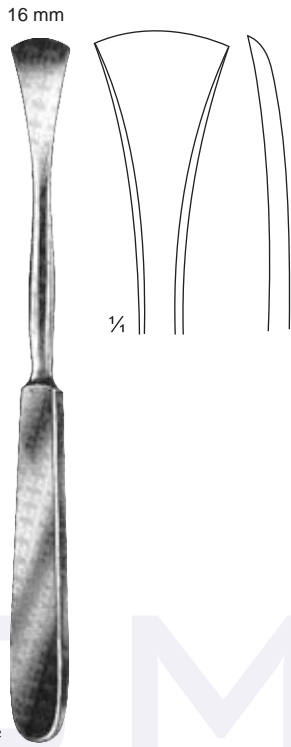

**Langenbeck**  
DC14-501-19  
19cm/7 1/2"



**Cushing**  
DC14-503-19  
19cm/7 1/2"



**Lambotte**  
21cm/8 1/4"

05 mm	DC14-505-05
10 mm	DC14-505-10
15 mm	DC14-505-15
20 mm	DC14-505-20
25 mm	DC14-505-25

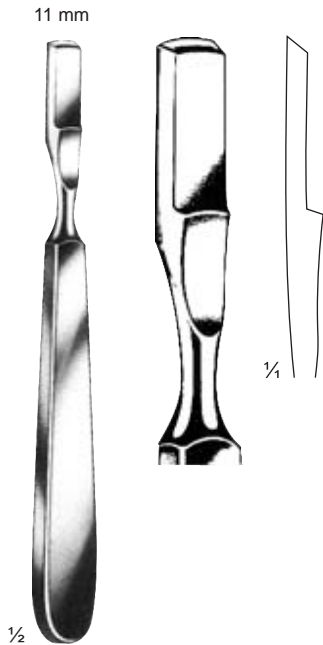

**Farabeuf-Collin**  
DC14-507-15  
15.5cm/6"

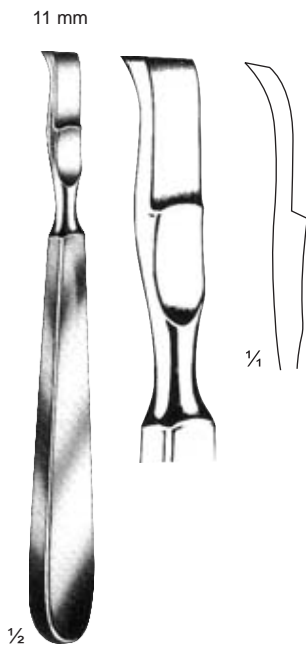

**Farabeuf-Collin**  
DC14-509-15  
15.5cm/6"

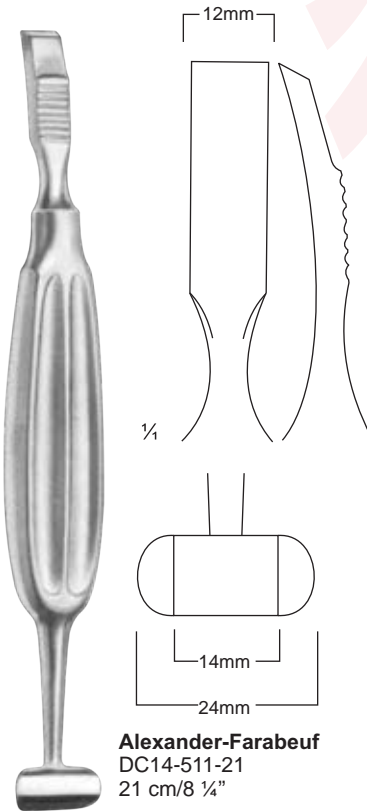

**Alexander-Farabeuf**  
DC14-511-21  
21 cm/8 1/4"



**Sewall**  
DC14-513-20  
20cm/8"

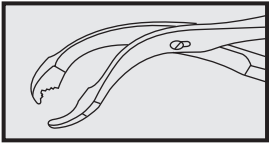

Raspatories



**Matson**  
DC14-515-22  
22 cm/8 3/4"



**Doyen**  
DC14-517-17  
DC14-521-17  
17 cm/6 3/4"

**Doyen**  
DC14-519-17  
DC14-523-17  
17 cm/6 3/4"

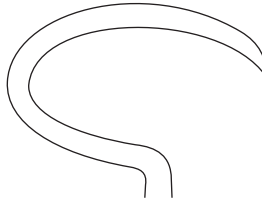

DC14-517-17  
DC14-517-24

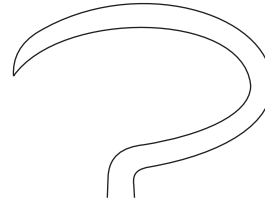

DC14-519-17  
DC14-519-24

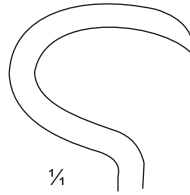

DC14-521-17



DC14-523-17

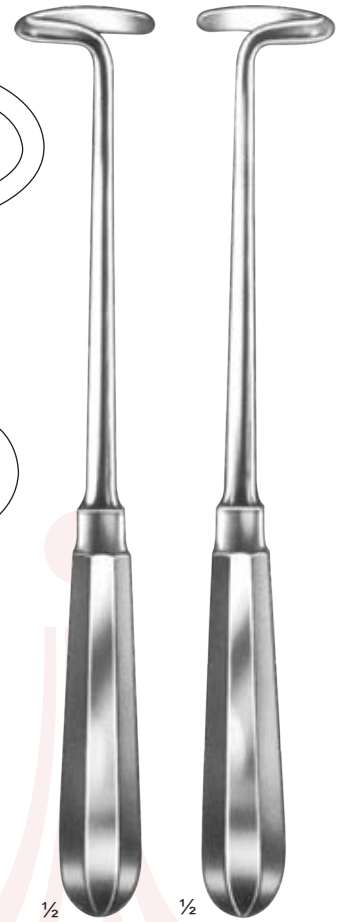

**Doyen**  
DC14-517-24  
24 cm/9 1/2"

**Doyen**  
DC14-519-24  
24 cm/9 1/2"

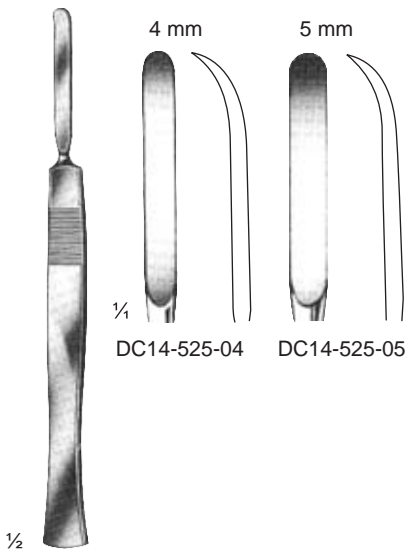

**McKenty**  
15cm/6"

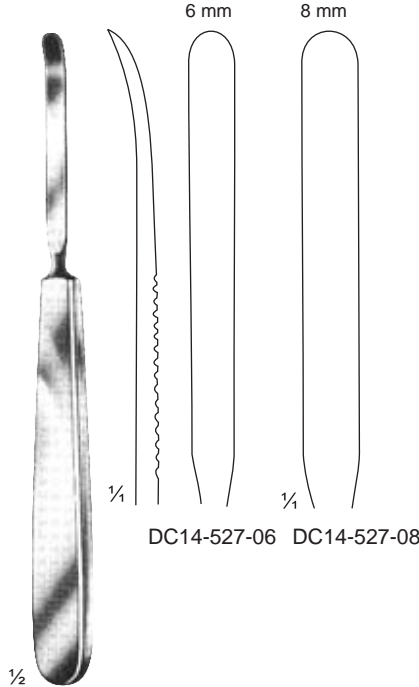

17cm/6 3/4"

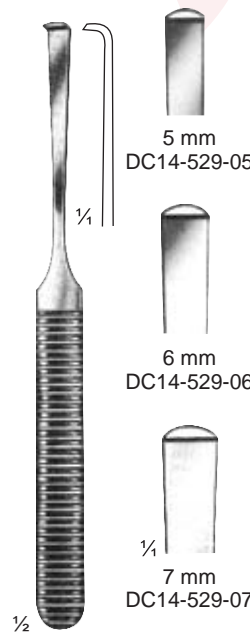

16cm/6 1/4"

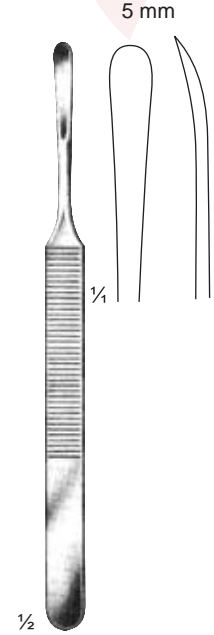

**König**  
DC14-531-05  
15.5cm/6"

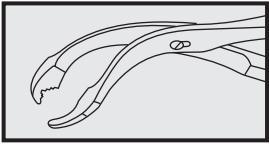

**Fomon**  
DC14-533-17  
17cm/6 3/4"



**Joseph**  
DC14-535-16  
16cm/6 1/4"



**Joseph**  
DC14-537-16  
16cm/6 1/4"

ACMA  
INTERNATIONAL

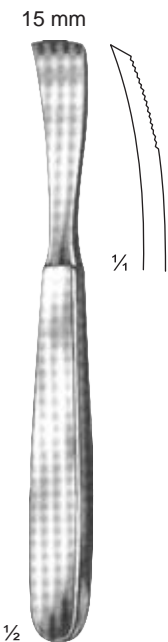

**Jansen**  
DC14-539-16  
16.5cm/6 1/2"

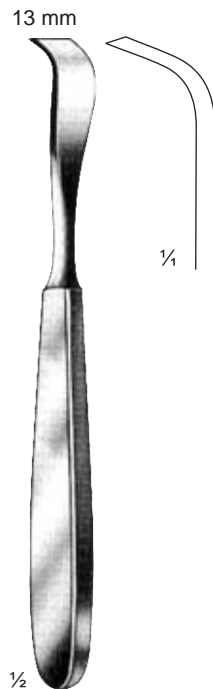

**Schneider**  
DC14-541-17  
17.5cm/7"



**Schneider-Sauerbruch**  
DC14-543-19  
19cm/7 1/2"

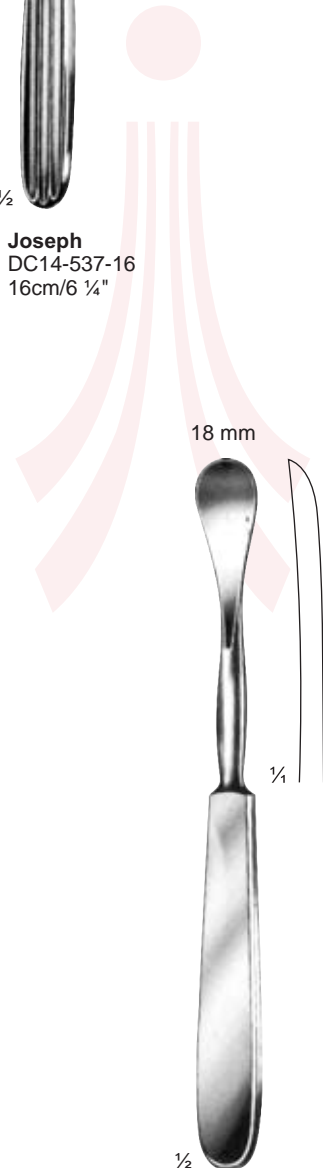

**Sedillot**  
DC14-545-18  
18cm/7"

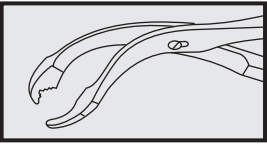



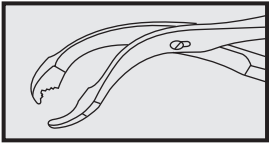

Septum Elevators and Raspatories

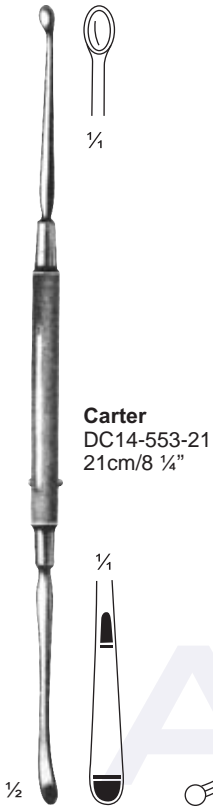

**Carter**  
DC14-553-21  
21cm/8 1/4"

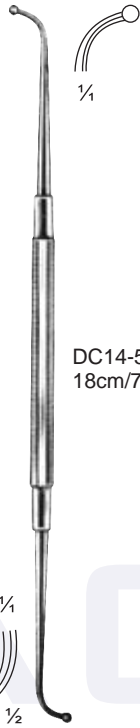

DC14-555-18  
18cm/7"



**Joseph-Masing**  
DC14-557-22  
22cm/8 3/4"



**Howarth**  
DC14-559-21  
21cm/8 1/4"

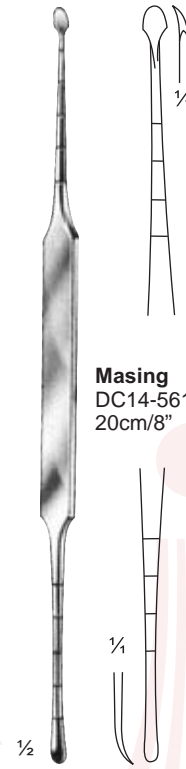

**Masing**  
DC14-561-20  
20cm/8"

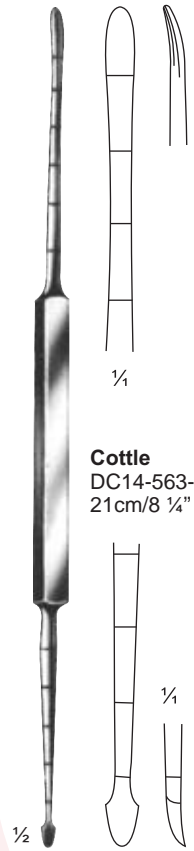

**Cottle**  
DC14-563-21  
21cm/8 1/4"



**Cottle**  
DC14-565-23  
23cm/9"

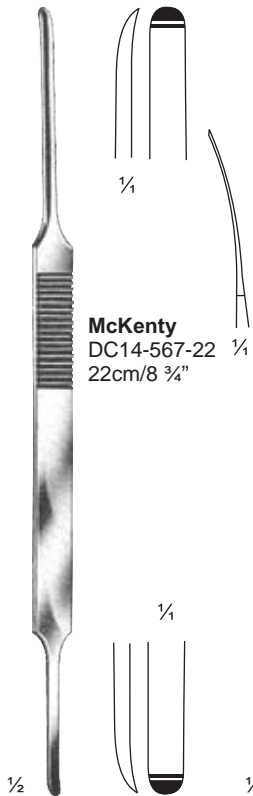

**McKenty**  
DC14-567-22  
22cm/8 3/4"



**Killian**  
DC14-569-18  
15cm/7"

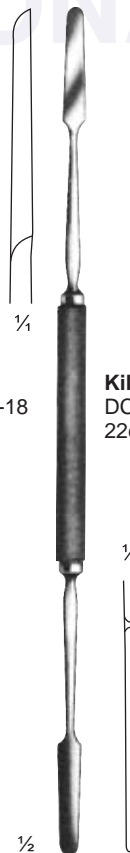

**Killian**  
DC14-569-22  
22cm/8 3/4"



**Pierce**  
DC14-571-21  
21cm/8 1/4"



**Pennington**  
DC14-573-21  
21cm/8 1/4"

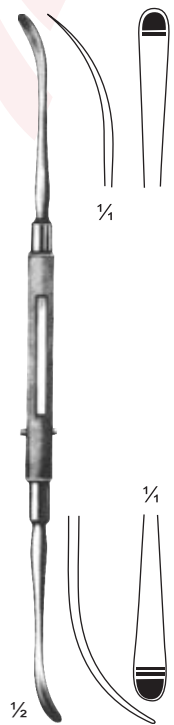

**Roger**  
DC14-575-19  
19cm/7 1/2"

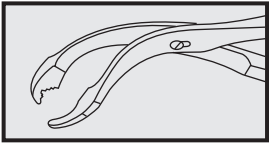

Elevators, Raspatories

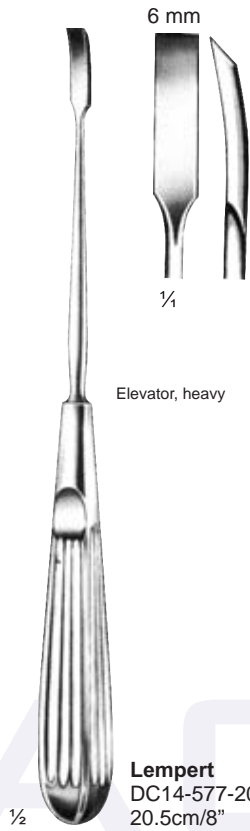

**Lempert**  
DC14-577-20  
20.5cm/8"

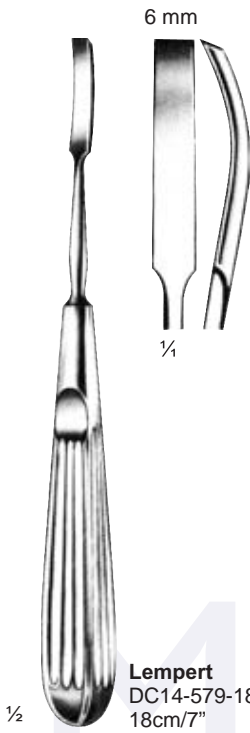

**Lempert**  
DC14-579-18  
18cm/7"

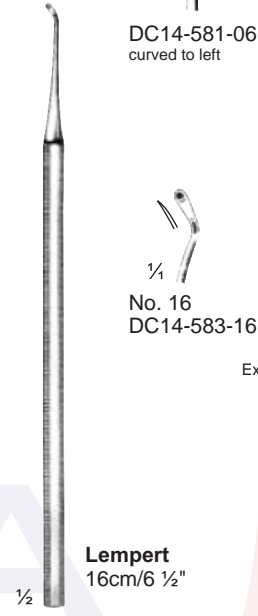

DC14-581-06  
curved to left

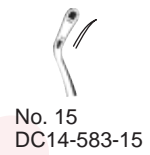
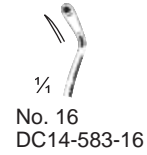

Excavator

Septum Elevators

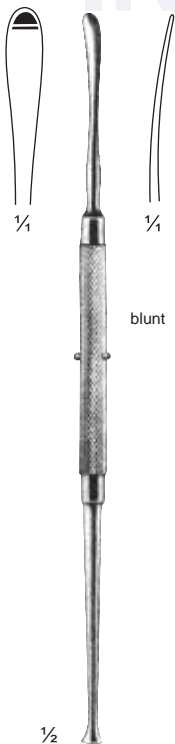

**Freer**  
DC14-585-01  
19cm/7 1/2"

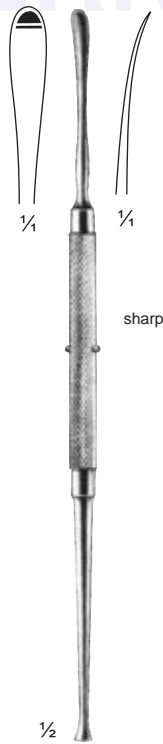

**Freer**  
DC14-585-02  
19cm/7 1/2"

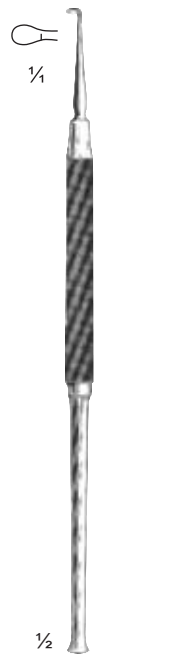

**Freer**  
DC14-585-17  
17cm/6 3/4"



**Freer**  
DC14-587-18  
18cm/7"

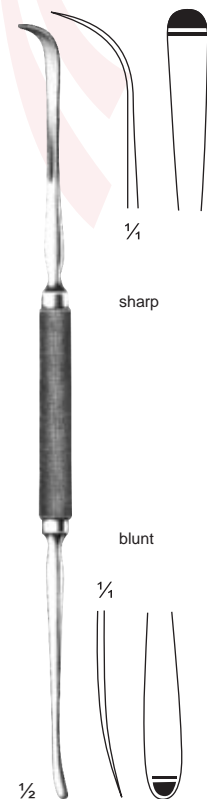

**Freer**  
DC14-587-20  
20cm/8"

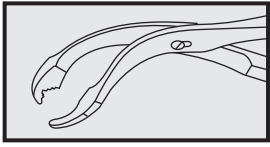

Periosteal Raspatories & Elevators

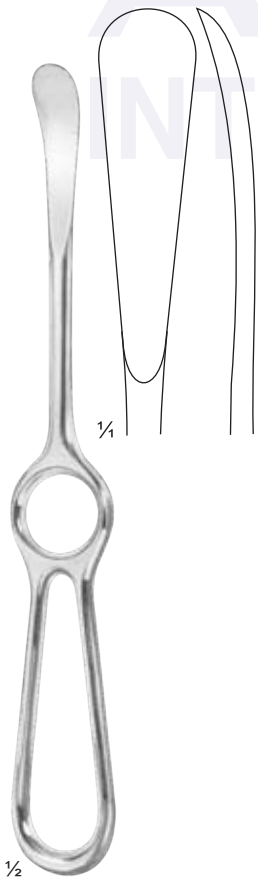
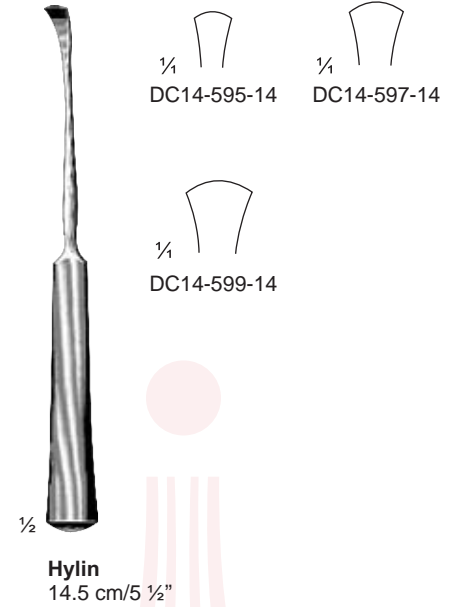
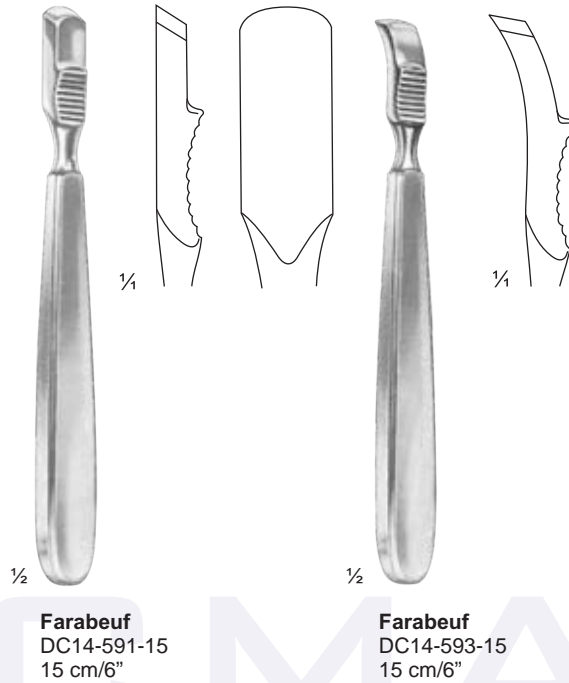
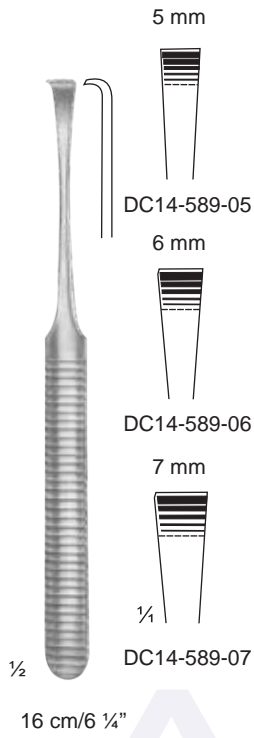

**Sedillot**  
DC14-601-21  
21 cm / 8 1/4"

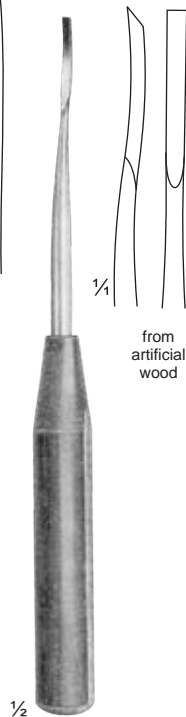

DC14-603-18  
18 cm / 7"



DC14-605-18  
18 cm / 7"

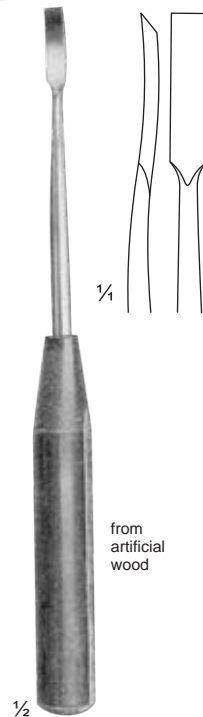

DC14-607-18  
18 cm / 7"

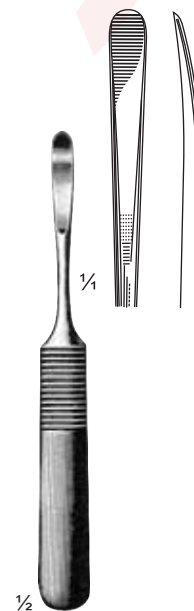

**Williger**  
DC14-609-13  
13 cm / 5"

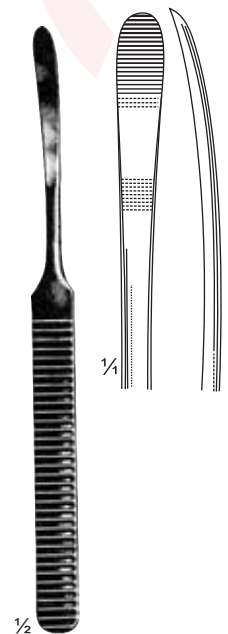

**Williger**  
DC14-611-16  
16 cm / 6 1/4"

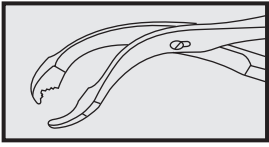

Costal Periosteotomes, Raspatories, Elevators

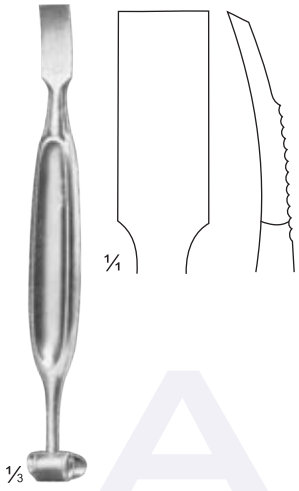

**Alexander**  
DC14-613-20  
20 cm/8"



**Matson**  
DC14-615-22  
22 cm/8 3/4"



**Overholt**  
DC14-617-29  
29.5 cm/11 1/2"



**Overholt**  
DC14-619-29  
29.5 cm/11 1/2"



**Overholt**  
DC14-621-28  
28.5 cm/11"

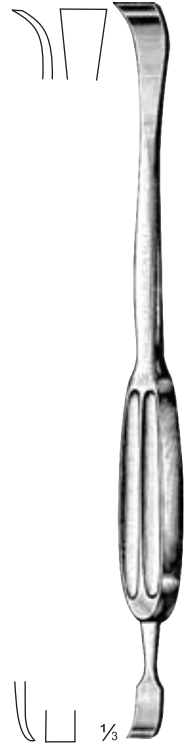

**Davidson-Alexander**  
DC14-623-29  
29 cm/11 1/2"



**Semb**



DC14-625-01  
17.5 cm/7"



DC14-625-02  
21 cm/8 1/4"



DC14-625-03  
17.5 cm/7"



DC14-625-04  
21 cm/8 1/4"



DC14-625-05  
20.5 cm/8"

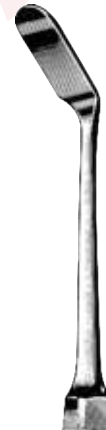

DC14-625-06  
20.5 cm/8"



DC14-625-07  
22.5 cm/9"

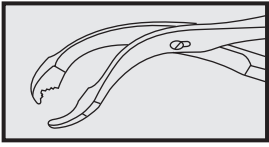

1/3

DC14-627-28  
28 cm/11"



1/3

DC14-629-24  
24.5 cm/9 3/4"



1/3

DC14-631-22  
22 cm/8 3/4"

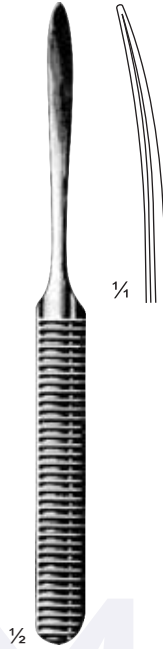

1/4

1/2

**Williger**  
DC14-633-17  
17 cm/6 3/4"

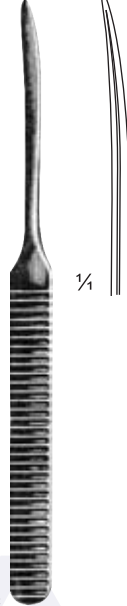

1/4

1/2

**Williger**  
DC14-635-16  
16 cm/6 1/4"



1/2

**Yanakauer**  
DC14-637-18  
18 cm/7"



1/2

**Mass. Gen. Hosp.**  
DC14-639-15  
15 cm/6"



1/2

**Langenbeck**  
DC14-641-20  
20 cm/8"



1/2

**Langenbeck**  
DC14-643-20  
20 cm/8"



1/2

**Adson**  
17 cm/6 3/4"



1/4

DC14-645-17



DC14-647-17



DC14-649-17



DC14-651-17



11 mm

1/4

1/2

**Langenbeck**  
DC14-653-23  
23cm/9"

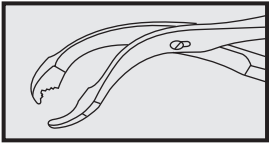

Elevators



**Killian**  
DC14-655-17  
17cm/6 3/4"



**Killian**  
DC14-657-17  
17cm/6 3/4"



**Killian**  
DC14-659-18  
17cm/6 3/4"

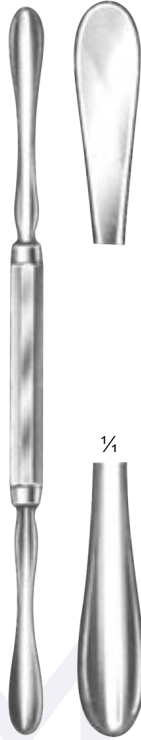

**Ballenger-Hajek**  
DC14-661-19 = 17cm/7 1/2"  
DC14-661-22 = 22cm/8 3/4"

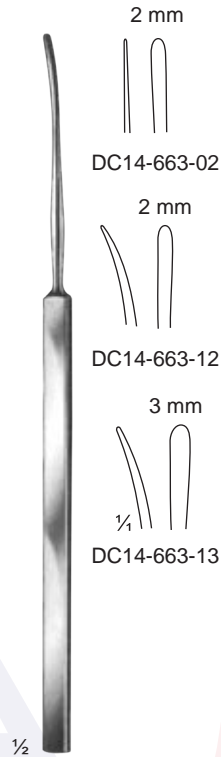

**Lempert**  
19cm/7 1/2"

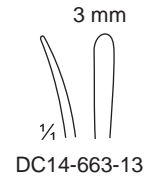

DC14-663-13

Elevator for pressing back  
lacrimal sac,  
3.5mm wide

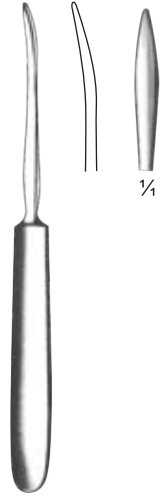

**Lueneburg**  
DC14-665-35  
12cm/4 3/4"



**Sebileau**  
DC14-667-17  
17cm/6 3/4"

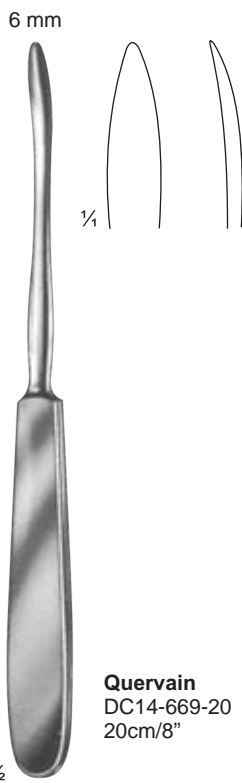

**Quervain**  
DC14-669-20  
20cm/8"



**Langenbeck**  
DC14-671-20  
20cm/8"

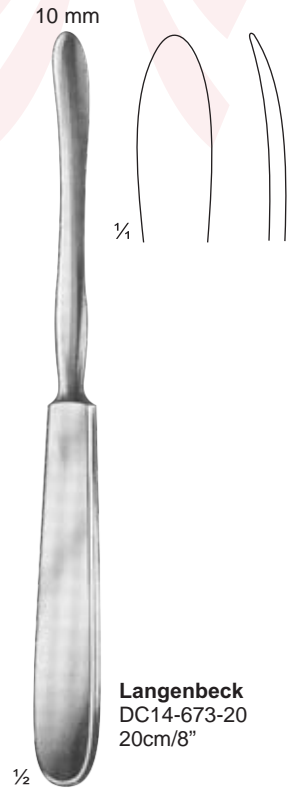

**Langenbeck**  
DC14-673-20  
20cm/8"

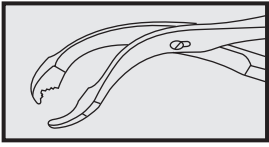

Elevators



**Alderdyce**  
DC14-675-21  
21 cm/8¼"



**McDonald**  
DC14-677-19  
19 cm/7½"



**Watson-Cheyne**  
DC14-679-17  
17.5 cm/7"

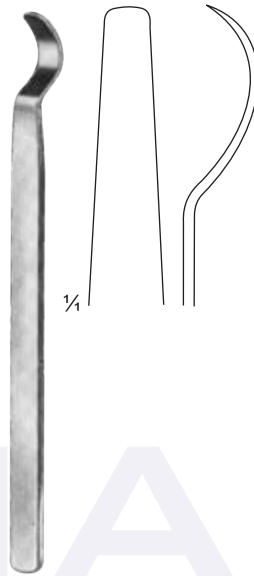

DC14-681-06  
14 cm/5½"



**Mini-Hohmann**  
16 cm/6¼"

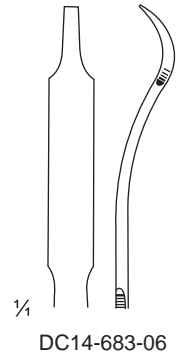

DC14-683-06

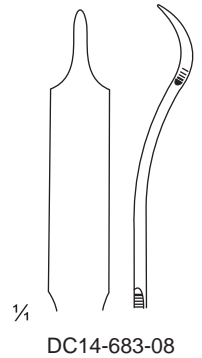

DC14-683-08

ACMA INTERNATIONAL



DC14-685-17  
17.5 cm/6¾"

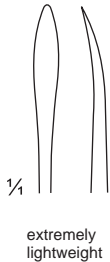

extremely  
lightweight



DC14-687-16  
16 cm/6¼"



Micro  
Elevator



**Key**  
19 cm/7½"

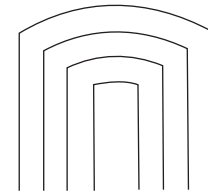

width	
mm	
6	DC14-689-06
12	DC14-689-12
19	DC14-689-19
25	DC14-689-25



DC14-691-16  
16 cm/6¼"

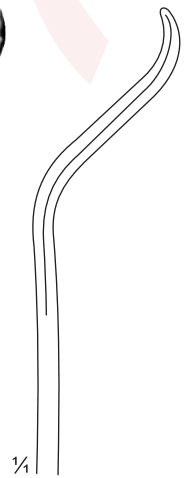

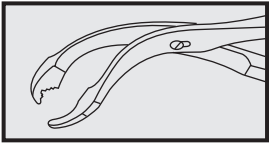

Dissectors, Elevators

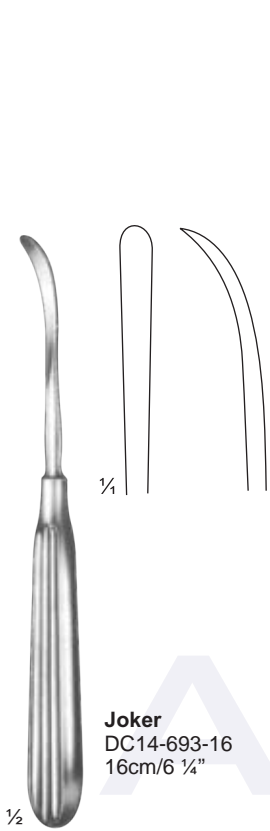

**Joker**  
DC14-693-16  
16cm/6 1/4"

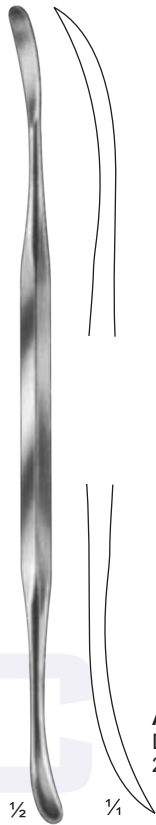

**Alderdyce**  
DC14-695-21  
21cm/8 1/4"



**McDonald**  
DC14-697-19  
19cm/7 1/2"

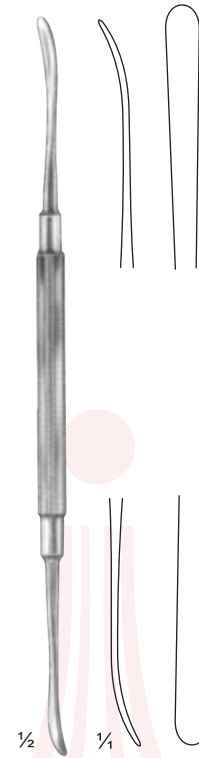

**Freer**  
DC14-699-18  
18.5cm/7 1/4"

ACMA  
INTERNATIONAL



DC14-701-17  
17.5cm/6 3/4"



DC14-703-16  
16cm/6 1/4"



**Halle**  
DC14-705-16  
16cm/6 1/4"



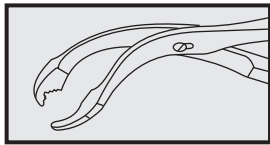

Dura Separators, Zygoma Elevators

Zygoma Elevatos



**Dingman**  
DC14-709-21  
21cm/8 1/4"

1/2



**Gillies**  
DC14-711-21  
21cm/8 1/4"

1/2



**Gillies**  
DC14-713-21  
21cm/8 1/4"

1/2



**Frazier**  
DC14-715-01  
15cm/6"

1/2



**Hoehn**  
DC14-715-45  
15cm/6"

1/2



**Hoehn**  
DC14-715-90  
15cm/6"

1/2

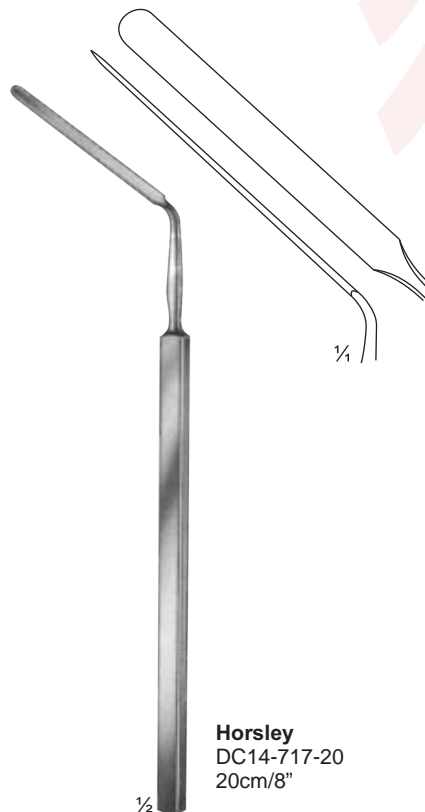

**Horsley**  
DC14-717-20  
20cm/8"

1/2



**Sachs**  
DC14-719-21  
21cm/8 1/4"

1/2

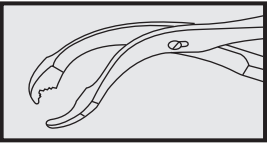

Dissectors, Dura Separators

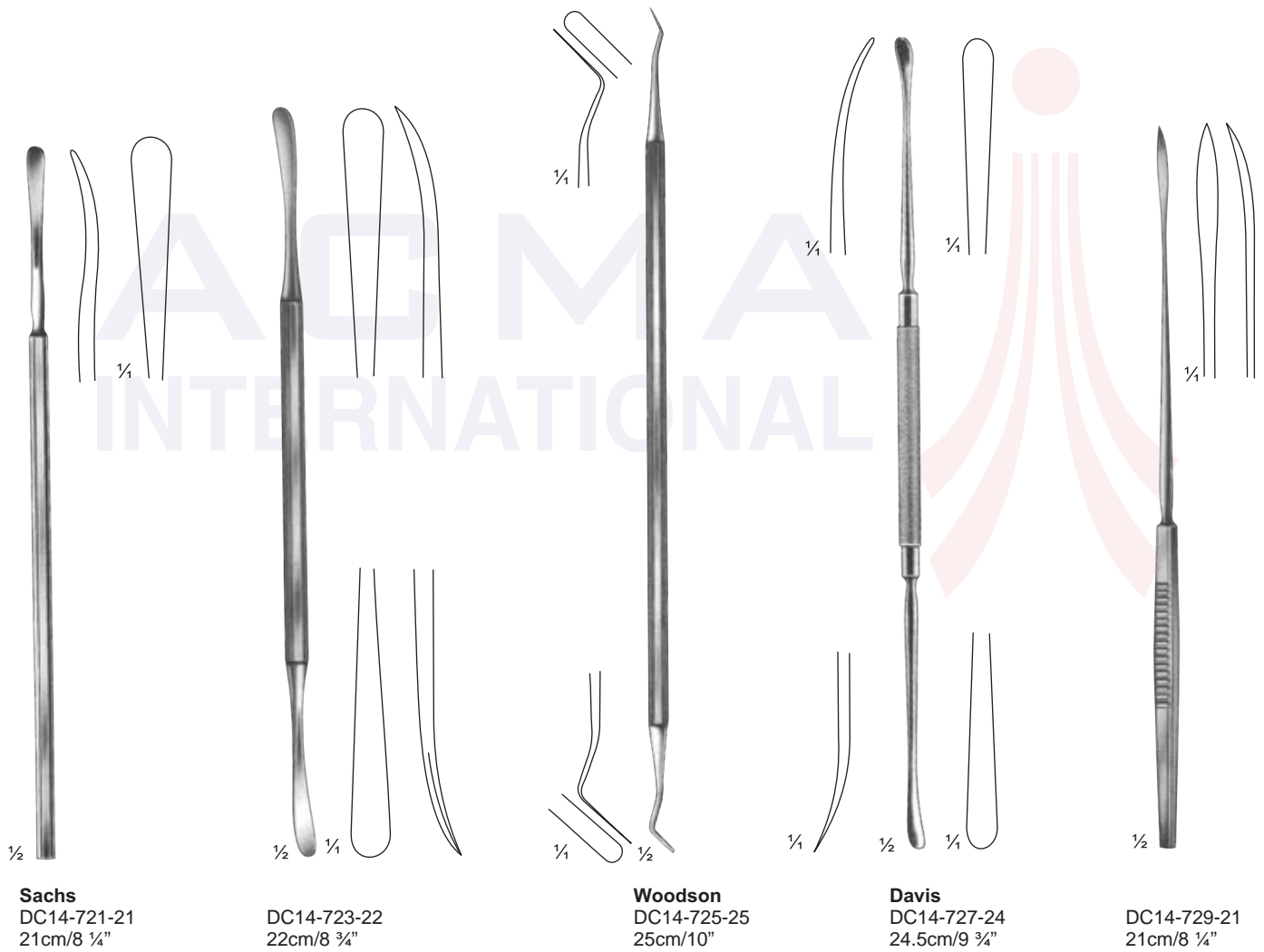

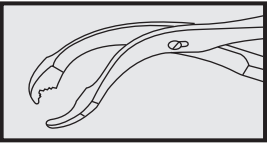

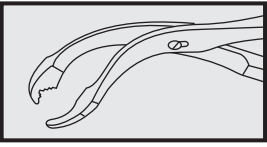

**Penfield**  
Fig. 1  
DC14-739-01  
17.5cm/7"

**Penfield**  
Fig. 2  
DC14-739-02  
19.5cm/7 3/4"

**Penfield**  
Fig. 3  
DC14-739-03  
19.5cm/7 3/4"

**Penfield**  
Fig. 4  
DC14-739-04  
20cm/8"

**Penfield**  
Fig. 5  
DC14-739-05  
29cm/11"

Rasps, Type Fomon

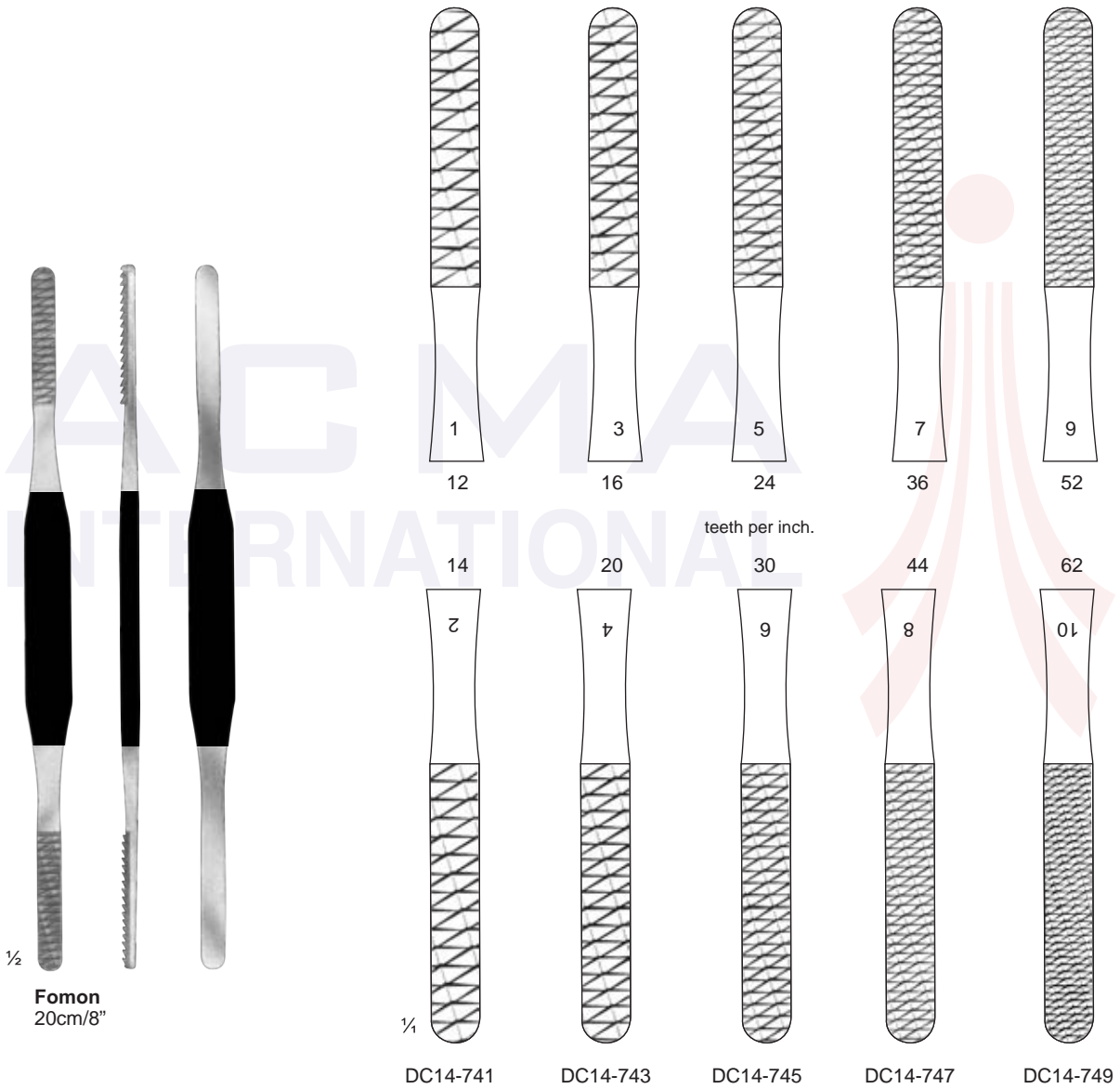
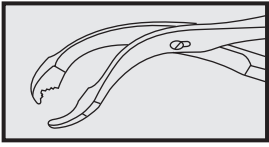

Rasps, Type Maltz, Miller

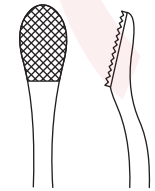
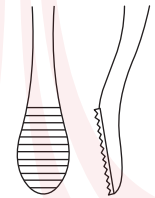
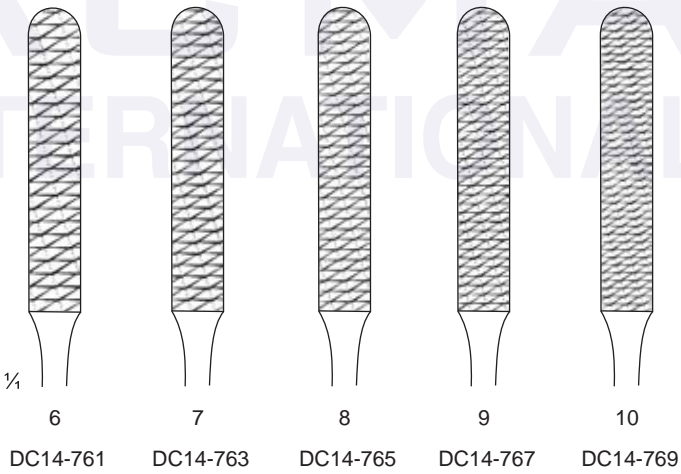
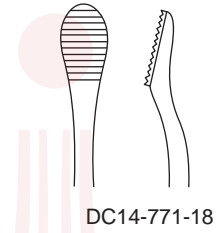
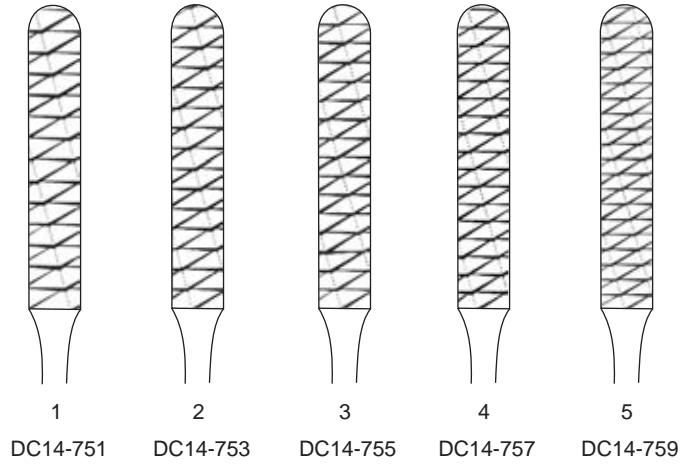
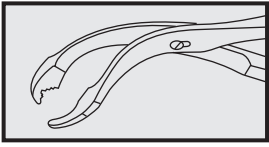

DC14-773-18



**Maltz**  
18cm/7"



**Miller**  
18cm/7"

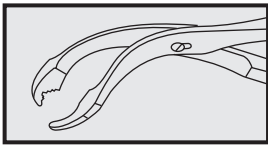

Bone Levers

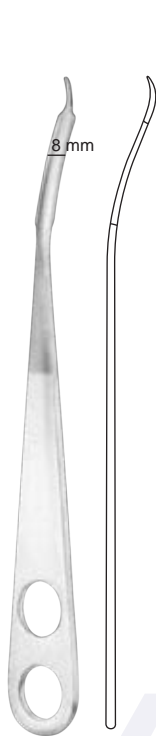

**Hohmann**  
DC14-775-08  
8 mm

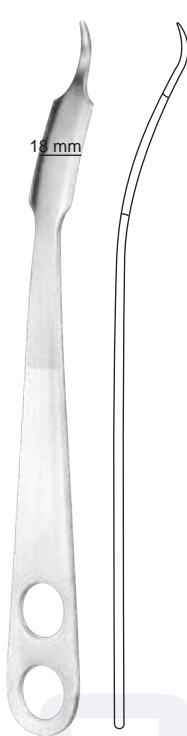

**Hohmann**  
DC14-775-18  
18 mm

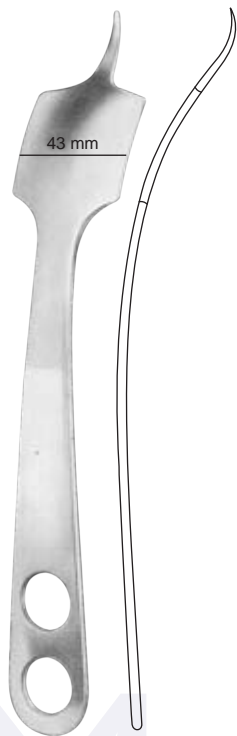

**Hohmann**  
DC14-775-43  
43 mm

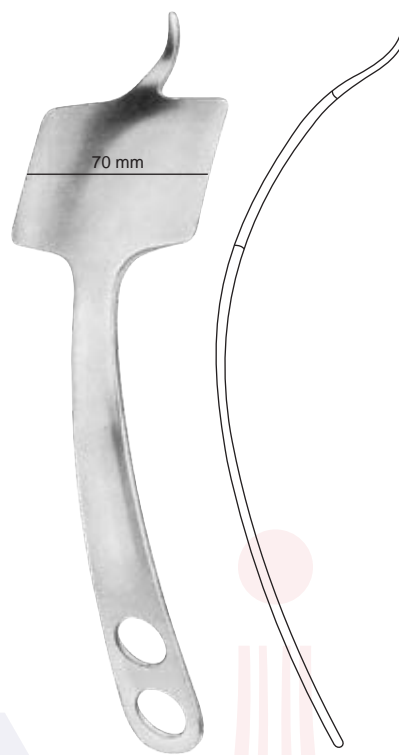

**Hohmann**  
DC14-775-70  
70 mm



**Hohmann**  
DC14-777-43  
43 mm



**Hohmann**  
DC14-779-22  
22 mm



**Hohmann**  
DC14-779-35  
33 mm

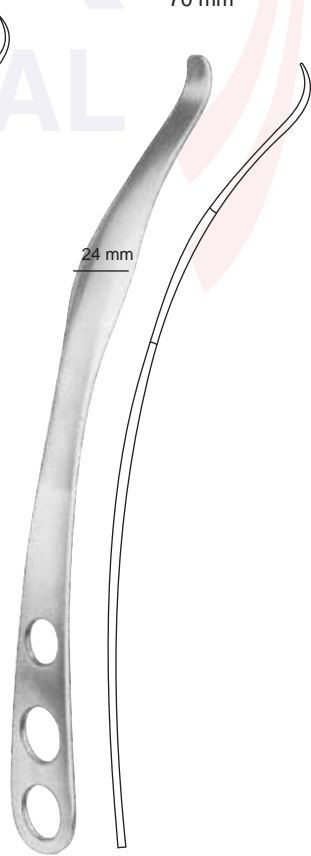

DC14-781-24  
24 mm



**Lange-Hohmann**  
DC14-783-22  
22 mm

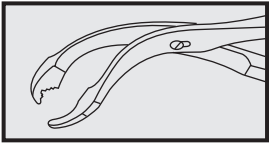

Bone Levers

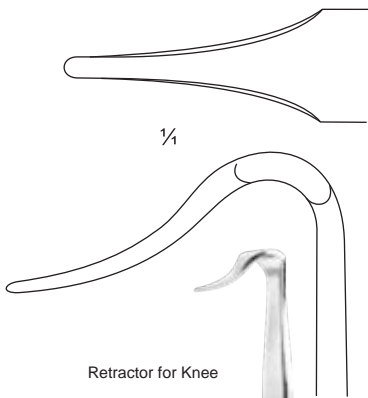

Retractor for Knee

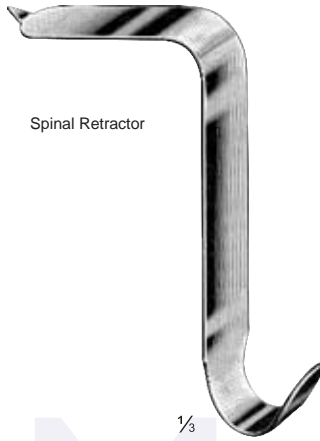

Spinal Retractor



**Blount**  
DC14-791-26  
26 cm/10¼"



**Blount**  
DC14-793-26  
26 cm/10¼"

**Blount**  
DC14-785-17  
17.5 cm/7"

**Taylor**  
DC14-787-16 16.5 cm/6½"  
75 x 30 mm

**Taylor**  
DC14-789-16 16.5 cm/6½"  
100 x 30 mm



**Lane**  
DC14-795-34  
34 cm/13½"



**Lange-Hohmann**  
DC14-797-27 27 cm/10½"  
DC14-797-29 29 cm/11½"



**Lange-Hohmann**  
DC14-799-27 27 cm/10½"  
DC14-799-29 29 cm/11½"



**Bennett**  
DC14-801-24  
24 cm/9½"



Meniscotomy Knives

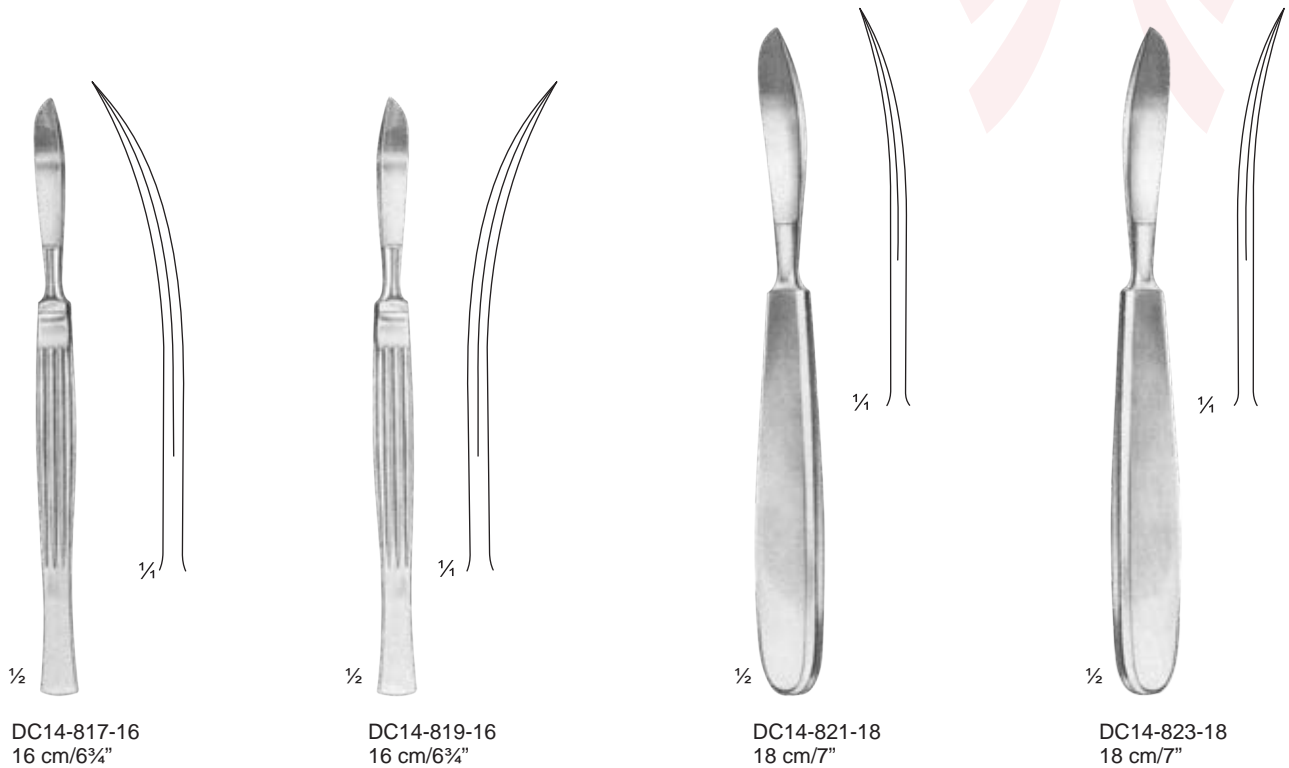
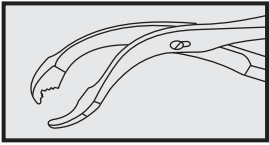

Tendon Seizing Instruments

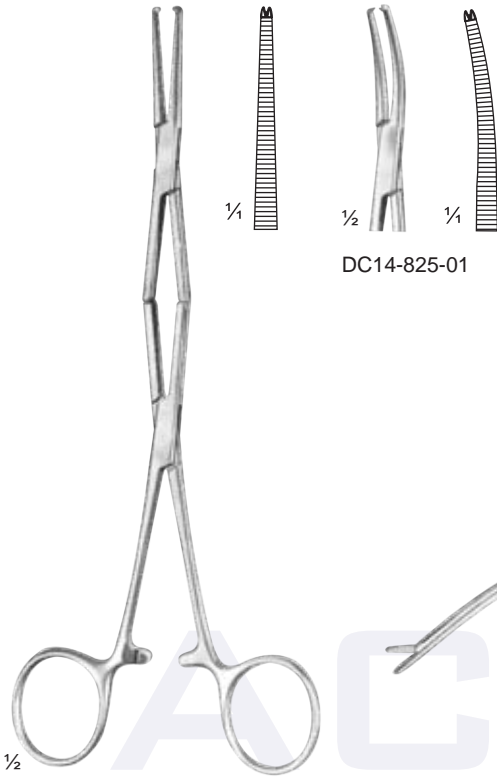
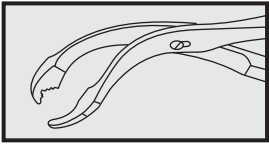

DC14-825-01

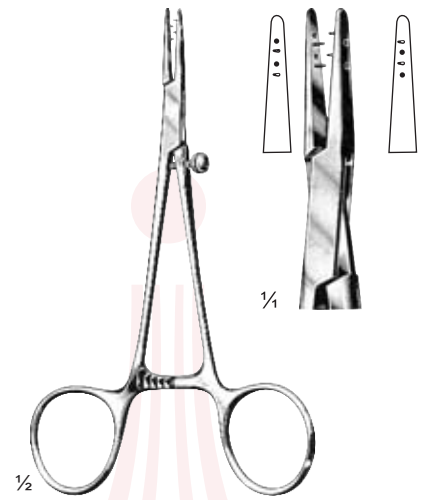

DC14-829-13  
13 cm / 5"

DC14-825-00  
20.5 cm / 8"

DC14-827-11  
11 cm / 9"

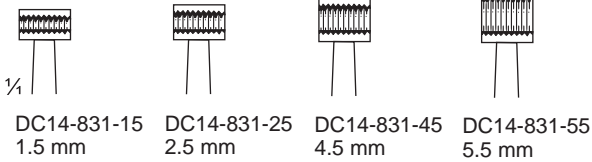

DC14-831-15 1.5 mm  
DC14-831-25 2.5 mm  
DC14-831-45 4.5 mm  
DC14-831-55 5.5 mm



1/2  
10 cm / 4"



**Steinmann**  
DC14-833-16  
16 cm / 6 1/4"



**Brand**  
DC14-835-15 = 15 cm / 6"  
DC14-835-19 = 19 cm / 7 1/2"  
DC14-835-24 = 24 cm / 9 1/2"

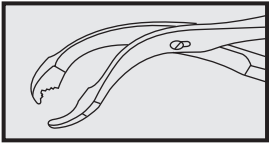

Meniscus- and Cartilage Forceps

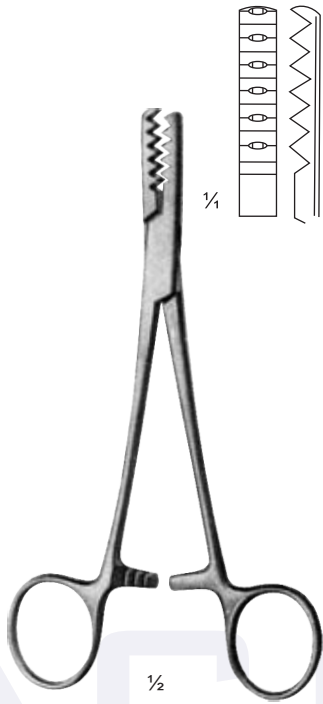

**Martin**  
DC14-837-16  
16 cm/6 1/4"



**Martin**  
DC14-837-19  
19.5 cm/7 3/4"

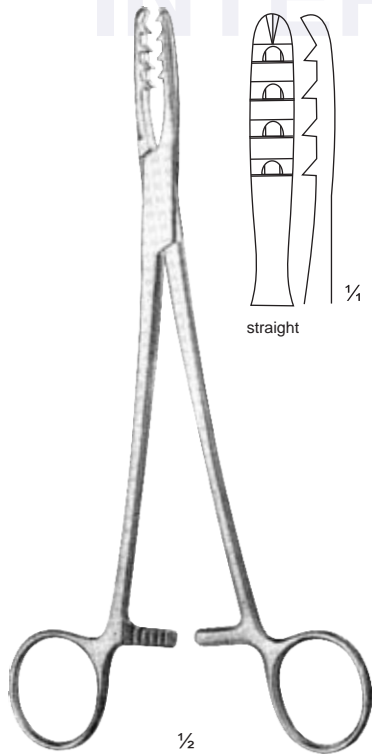

**Bircher-Ganske**  
DC14-839-20  
20 cm/8"

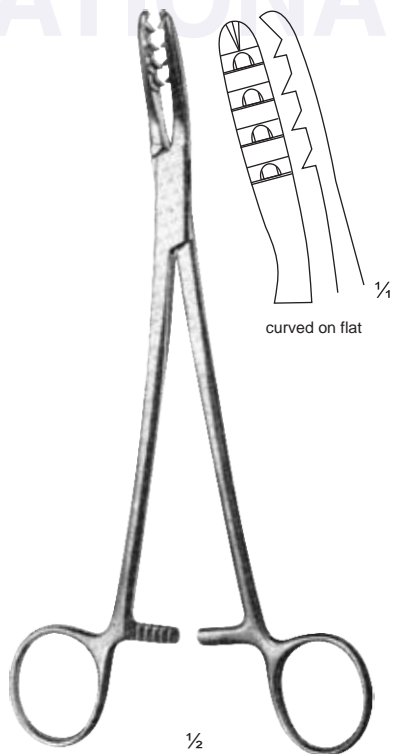

**Bircher-Ganske**  
DC14-841-20  
20 cm/8"

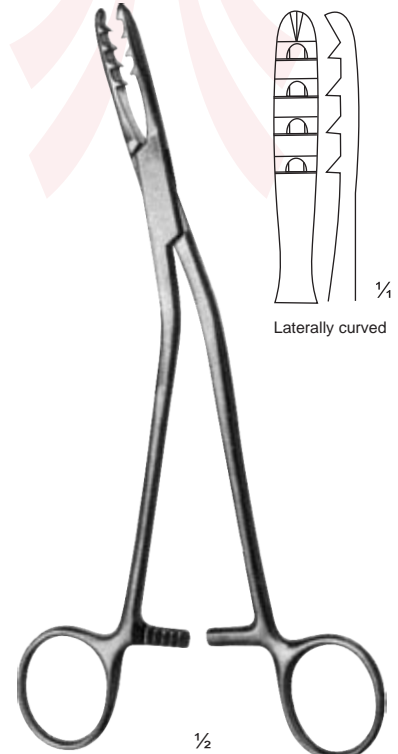

**Bircher-Ganske**  
DC14-843-20  
20 cm/8"

Nail Instruments, Finger Ring Saws

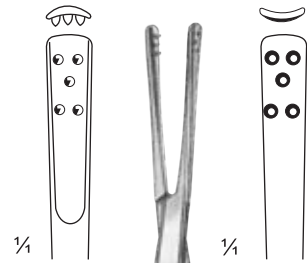
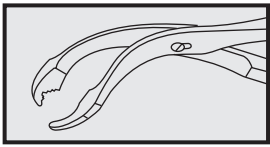

1/4

1/4

1/2

DC14-845-16  
15.5 cm/5 3/4"



DC14-849-01

1/2

DC14-847-17



1/2

Mod. Martin  
DC14-851-17  
DC14-853-01

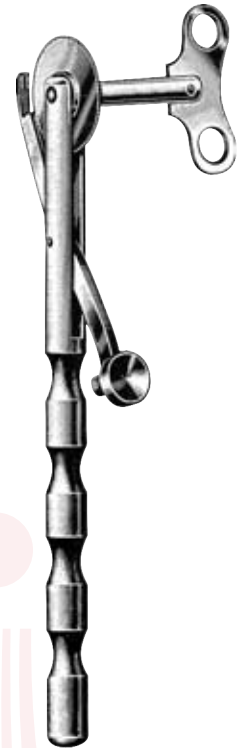

Smith  
DC14-855-19  
DC14-853-01

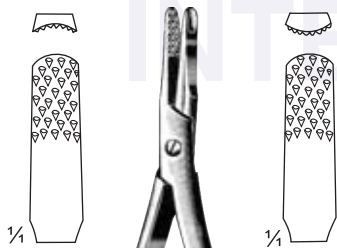

1/4

1/4

1/2

Radolf  
DC14-857-13  
13.5 cm/5 1/4"



1/2

Feldheim  
DC14-859-10  
10cm/4"



1/4

Simplex  
DC14-861-19

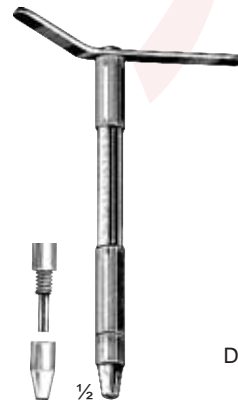

1/2

Martin-Ideal  
DC14-863-10



DC14-865-01



DC14-865-02



DC14-865-03

DC14-865-00 = Set

- DC14-851-17 - Finger Ring Saw, with protecting housing, complete
- DC14-855-19 - Finger Ring Saw, complete
- DC14-853-01 - Saw Blade only for No.DC14-851-17 and DC14-855-19
- DC14-849-01 - Saw Blade for No. DC14-855-17
- DC14-845-16 } - Forceps for tearing out toe and finger nails
- DC14-857-13 }

- DC14-859-10 - Tourniquet for fingers and toes, with woven, unbreakable metal strap
- DC14-861-19 - Finger Nail Drill, With 1 drill point
- ditto, with moveable hand support and chuck, drill points nested in the handle:
- DC14-863-10 - complete with 3 drill points of different sizes
- DC14-865-00 - Set of drill points only
- DC14-865-01 - 03 - Drill points single